

**Handbook  
for the  
Palm IIIc™ Organizer**

## Copyright

Copyright © 1998-1999 Palm Computing, Inc. or its subsidiaries. All rights reserved. Graffiti, HotSync, Palm Computing, PalmConnect, PalmModem, and Palm OS are registered trademarks, and the HotSync logo, Palm, Palm III, Palm IIIc, and the Palm IIIc logo are trademarks of Palm Computing, Inc. or its subsidiaries. Other product and brand names may be trademarks or registered trademarks of their respective owners.

## Disclaimer and Limitation of Liability

Palm Computing, Inc. and its subsidiaries assume no responsibility for any damage or loss resulting from the use of this handbook.

Palm Computing, Inc. and its subsidiaries assume no responsibility for any loss or claims by third parties which may arise through the use of this software. Palm Computing, Inc. and its subsidiaries assume no responsibility for any damage or loss caused by deletion of data as a result of malfunction, dead battery, or repairs. Be sure to make backup copies of all important data on other media to protect against data loss.

**Important:** Please read the End User Software License Agreement with this product before using the accompanying software program(s). Using any part of the software indicates that you accept the terms of the End User Software License Agreement.

## 3.5" Software Diskettes Available

Palm™ Desktop software is supplied on a CD-ROM disc. If you do not have access to a CD-ROM drive for your computer, you may download the Palm Desktop software from <http://www.palm.com>. Alternatively, you can order 3.5" diskettes by completing and mailing the diskette order card supplied in the Palm IIIc™ organizer product package, or call to order the diskettes. See the Worldwide Customer Support card for the appropriate phone number.

P/N: 406-1243-01  
A/N: 423-1243-01

# Contents

<b>About This Book</b> .....	1
<b>Chapter 1: Introduction to Your Palm IIIc™ Organizer</b>	
Getting to know your Palm IIIc organizer.....	3
What is a Palm IIIc organizer? .....	3
System requirements .....	4
Upgrade Information .....	4
Palm IIIc components .....	6
Recharging the battery .....	11
Palm Desktop organizer software .....	12
Using your organizer with another PIM .....	14
Tapping and typing .....	15
Tap with the stylus to get things done .....	15
Elements of the organizer interface .....	16
Opening applications .....	17
Using menus .....	18
Four ways to enter data .....	21
Customizing your organizer.....	24
<b>Chapter 2: Entering Data in Your Palm IIIc™ Organizer</b>	
Using Graffiti writing to enter data .....	27
Writing Graffiti characters .....	27
Graffiti tips .....	29
The Graffiti alphabet .....	30
Writing capital letters .....	30
Writing numbers .....	31
Graffiti numbers .....	32
Writing punctuation marks .....	32
Additional Graffiti punctuation .....	33
Writing symbols and extended characters .....	33
Writing accented characters .....	34
Accent strokes .....	34
Additional non-English characters .....	34
Navigation strokes .....	35
Graffiti ShortCuts .....	35
Using the onscreen keyboard .....	36
Using your computer keyboard .....	37
Importing data .....	37

### Chapter 3: Managing Your Applications

Using the Applications Launcher .....	39
Selecting applications .....	39
Switching between applications .....	39
Categorizing applications .....	39
Changing the Applications Launcher display .....	40
Choosing preferences.....	41
Installing and removing applications.....	42
Installing add-on applications .....	42
Installing games .....	44
Removing applications .....	45
Removing Palm Desktop software .....	45
Security.....	46
Assigning a password .....	46
Changing or deleting a password .....	47
Locking your organizer .....	47
Recovering from a forgotten password .....	48

### Chapter 4: Using Your Basic Applications

Overview of basic applications.....	50
Date Book .....	50
Address Book .....	51
To Do List .....	52
Memo Pad .....	53
Calculator .....	53
Expense .....	54
Common tasks.....	55
Creating records .....	55
Editing records .....	55
Deleting records .....	57
Purging records .....	58
Exchanging and updating data: HotSync operations .....	58
Categorizing records .....	61
Finding records .....	64
Sorting lists of records .....	69
Making records private .....	70
Attaching notes .....	72
Choosing fonts .....	73
Application-specific tasks.....	74
Date Book .....	74
Address Book .....	88
To Do List .....	93
Memo Pad .....	98

Calculator .....	101
Expense .....	103

## **Chapter 5: Communicating Using Your Organizer**

Managing desktop E-Mail away from your desk.....	115
Setting up Mail on the desktop .....	116
Synchronizing Mail with your E-Mail application .....	118
Opening the Mail application on your organizer .....	118
Viewing e-mail items .....	118
Creating e-mail items .....	119
Looking up an address .....	122
Adding details to e-mail items .....	123
Storing e-mail to be sent later .....	126
Editing unsent e-mail .....	126
Draft e-mail .....	127
Filing e-mail .....	128
Deleting e-mail .....	129
Removing e-mail from the Deleted folder .....	129
Purging deleted e-mail .....	130
Message list options .....	130
HotSync options .....	132
Creating special filters .....	133
Truncating e-mail items .....	137
Mail menus .....	138
Beaming information .....	139

## **Chapter 6: Advanced HotSync® Operations**

Selecting HotSync setup options.....	143
Customizing HotSync application settings .....	146
IR HotSync operations.....	148
Preparing your computer for infrared communication .....	148
Configuring HotSync Manager for infrared communication .....	151
Performing an IR HotSync operation .....	152
Returning to cradle HotSync operations .....	152
Conducting a HotSync operation via modem.....	153
Preparing your computer .....	153
Preparing your organizer .....	155
Selecting the conduits for a modem HotSync operation .....	156
Performing a HotSync operation via a modem .....	157
Conducting a HotSync operation via a network.....	158
Connecting to your company's dial-in server .....	158
Performing a network HotSync operation .....	161
Using File Link.....	161
Creating a user profile .....	162

## Chapter 7: Setting Preferences for Your Organizer

Viewing preferences.....	165
Buttons preferences .....	166
Pen preferences .....	166
HotSync buttons preferences .....	168
Digitizer preferences .....	168
Formats preferences .....	168
Country default .....	169
Time, date, week start, and numbers formats .....	169
General preferences .....	170
Auto-off delay .....	170
Cradle settings .....	170
System, alarm, and game sounds .....	171
Beam Receive .....	171
Connection preferences.....	172
Sample connection for remote IR HotSync operations .....	173
Network preferences and TCP/IP software .....	175
Selecting a service .....	175
Entering a user name .....	176
Entering a password .....	177
Selecting a connection .....	177
Adding telephone settings .....	178
Connecting to your service .....	180
Creating additional service templates .....	181
Adding detailed information to a service template .....	181
Login scripts .....	184
Creating a login script on your organizer .....	185
Plug-in applications .....	187
Deleting a service template .....	187
Network preferences menu commands .....	187
TCP/IP troubleshooting .....	188
Owner preferences.....	189
ShortCuts preferences .....	190
Creating a ShortCut .....	190
Editing a ShortCut .....	191
Deleting a ShortCut .....	191

## Appendix A: Maintaining Your Organizer

Caring for your organizer.....	193
Battery considerations.....	195
Resetting your organizer .....	195
Performing a soft reset .....	195
Performing a hard reset .....	196

<b>Appendix B: Frequently Asked Questions</b>	
Software installation problems.....	200
Operating problems .....	201
Tapping and writing problems .....	202
Application problems .....	203
HotSync problems .....	204
Beaming problems.....	210
Recharging problems.....	210
Password problems.....	211
Technical support.....	212
<b>Appendix C: Creating a Custom Expense Report</b>	
About mapping tables .....	213
Customizing existing sample templates .....	214
Determining the layout of the Expense Report.....	215
Labels .....	215
Sections .....	216
Analyzing your custom Expense Report .....	217
Programming the mapping table.....	218
Using applications other than Microsoft Excel .....	222
Expense file details.....	222
<b>Appendix D: Non-ASCII Characters for Login Scripts</b>	
Use of ^char .....	223
Carriage return and line feed .....	223
Literal characters .....	224
<b>Product Regulatory Information</b>	
FCC Statement .....	225
Canadian ICES-003 Statement .....	226
CE Compliance Statement.....	226
Battery Warning .....	226
<b>Index</b> .....	229





# About This Book

Welcome to the Palm IIIc™ connected organizer. This handbook is designed to help you get up and running quickly on your organizer. It describes all you need to know about how to use your Palm IIIc organizer and the applications that come with it.

It walks you through:

- Locating all the parts of your organizer
- Viewing and entering data
- Using your organizer with your computer
- Personalizing your organizer with your own preference settings

After you become familiar with the basic functionality of your organizer, you can use the rest of this handbook as a reference for less common tasks, for maintaining your organizer, and also as a source of information if you have problems operating it.



# Chapter 1

## Introduction to Your Palm IIIc™ Organizer

This chapter explains the physical buttons and controls on your Palm IIIc™ connected organizer, how to use your organizer for the first time, and how to use HotSync® technology to synchronize your organizer and Palm™ Desktop organizer software.

### Getting to know your Palm IIIc organizer

#### What is a Palm IIIc organizer?

With your Palm IIIc organizer, you will no longer have trouble getting to meetings and appointments on time, remembering people's names and personal details, or tracking all the items on your To Do list. Your organizer can help you improve your track record in all these areas, both at work and at home.

You can enter all your scheduled events in Date Book, and set an alarm to remind you of important meetings. You can view scheduled events by the day, week, or month, and you also have an agenda view for displaying current events and To Do items at the same time. Keep all your contact names, addresses, phone numbers, and other details in Address Book, so you can find them as soon as you need them. Add your tasks to To Do List, prioritize them so you don't overlook them, and assign them a due date.

To make sure you don't lose any of this important information, you can synchronize your data with Palm Desktop software on your computer so you always have a backup copy. You can set different levels of security for your organizer so unauthorized eyes cannot view your data.

When you are out of the office, track your expenses for your expense reports; then transfer the data to your computer to print it out. You can write, edit, and view your e-mail, and then synchronize your e-mail with your desktop E-Mail application when you return to your office.

## System requirements

To install and operate Palm Desktop software, your computer system must meet the following requirements:

### Minimum requirements

- Windows 95, Windows 98, or Windows NT 4.0
- IBM-compatible 486 computer or higher
- 8 MB RAM (memory) *minimum*,  
16 MB recommended
- 20 MB available hard disk space
- VGA monitor or better
- CD-ROM drive (you can also download the Palm Desktop software from <http://www.palm.com>, or order 3.5" diskettes from Palm Computing)
- Mouse
- One available serial port or USB port (PalmConnect® USB Kit sold separately)

### Optional equipment

- Modem (such as a PalmModem® accessory)
- Windows-compatible printer
- Infrared communication device

### Macintosh compatibility

You can connect your organizer to your Macintosh using the PalmConnect® Serial Kit or PalmConnect USB Kit (sold separately).

## Upgrade Information

If you already own a Palm Computing® handheld, we recommend that you install the version of Palm Desktop software that comes with your new Palm IIIc organizer into the same folder as your current Palm Desktop software. When you install the new version in the same folder as the previous version, all your data is preserved. If you use another personal information manager (PIM), you still need to install Palm Desktop software in order to add HotSync Manager, conduit software, and other features of Palm Desktop software to your computer.

You perform HotSync operations in exactly the same way, so you can quickly synchronize your old data with your new organizer.

**To upgrade:**

1. Read the Getting Started guide for an overview of the complete installation process.
2. Synchronize your old organizer with your old Palm Desktop software. This ensures that the latest information from your organizer is on your desktop computer.
3. (Optional) To ensure against any data loss, go to the folder that stores Palm Desktop software, copy the folder and all its contents, rename it (for example, Palm Backup), and store the copy outside the Palm Desktop software folder.
4. Follow the installation instructions in “Installing Palm Desktop software” later in this chapter. Be sure to install the new software in the same folder as the old software.
5. To prepare for the first HotSync operation that synchronizes your new organizer with your new Palm Desktop software, go to the HotSync Manager and choose Custom.

**Note:** Be sure your username appears in the box at the top of the Custom dialog box. If not, select your username.

6. For all conduits, click Change and select the option Desktop overwrites handheld. Then click Done. See “Customizing HotSync application settings” in Chapter 6 for more information.
7. Place your new organizer in the cradle and press the HotSync button. If the Select User dialog box appears, select your username.

**Note:** If you customized the modem setup on your old organizer, you must re-enter the modem init string.

Any passwords you set on your old organizer are not restored during this HotSync operation. Records you previously marked Private are still marked Private, but you need to reenter a password on your new organizer.

**Each organizer must have a unique name**

After you complete the upgrade process described above, you have two organizers with the same name. This is an undesirable situation. Each organizer must have a unique name in order to prevent unexpected results during HotSync operations and other complications.

We strongly recommend that you perform a hard reset on your old organizer. See “Performing a hard reset” in Appendix A for details.

A hard reset not only erases all data from the old organizer; it also erases the name and makes that organizer a clean slate, ready to receive a new name. The next time you perform a HotSync operation with this old organizer, you are asked to give it a name. Be sure to give it a unique name.

## Palm IIIc components

### Locating front panel controls

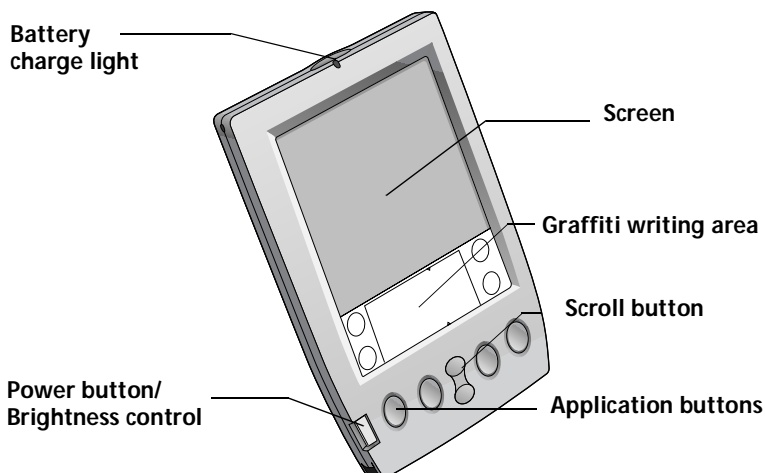

#### **Power button/ Brightness control**

Turns your organizer on or off and controls the brightness.

If your organizer is turned off, pressing the power button turns the organizer on and returns you to the last screen you viewed. Press the power button to turn the organizer off.

If you have difficulty seeing the information onscreen, use the brightness control to adjust the screen depending on the lighting conditions where you use your organizer. Press the power button and hold it down for about two seconds to access the Brightness dialog box. You can conserve battery life by reducing the brightness level of the display.

#### **Battery charge light**

Illuminates when the organizer is in the cradle and the battery is charging. When the battery is fully charged, the light turns off.

<b>Organizer screen</b>	Displays the applications and information stored in your organizer. It is touch-sensitive and responds to the stylus.
<b>Graffiti® writing area</b>	The area where you write letters and numbers using the Graffiti® alphabet. See Chapter 2 to learn how to write Graffiti characters.
<b>Scroll button</b>	Displays text and other information that extends beyond the area of the organizer screen. Pressing the lower half of the scroll button scrolls down to view information below the viewing area, and pressing the upper half of the button scrolls up to view the information above the viewing area.
<b>Application buttons</b>	Activates the individual organizer applications that correspond to the icons on the buttons: Date Book, Address Book, To Do List, and Memo Pad. See “Buttons preferences” in Chapter 7 for details on reassigning these buttons to activate any application on your organizer.
	<b>Tip:</b> If your organizer is turned off, pressing any application button activates the organizer and opens the corresponding application.

## Using the onscreen brightness control

You may need to make adjustments by changing the amount of brightness on the screen.

### To adjust the brightness:

1. Press the power button and hold it down for about two seconds.
2. Do one of the following:

To change the brightness in small increments, tap to the left or right of the slider.

To change the brightness in larger increments, drag the slider to the left or right.

**Tip:** You can also press the scroll button to move the slider incrementally.

3. Tap Done.

## Protective flip cover

The cover protects the organizer screen when it is not in use and helps reduce glare while you use your organizer. You can open the cover so that it is at an angle, open it fully, or remove it altogether by pulling the cover out of the holes on the sides of the organizer. To reattach the cover, reinsert the pegs in the holes.

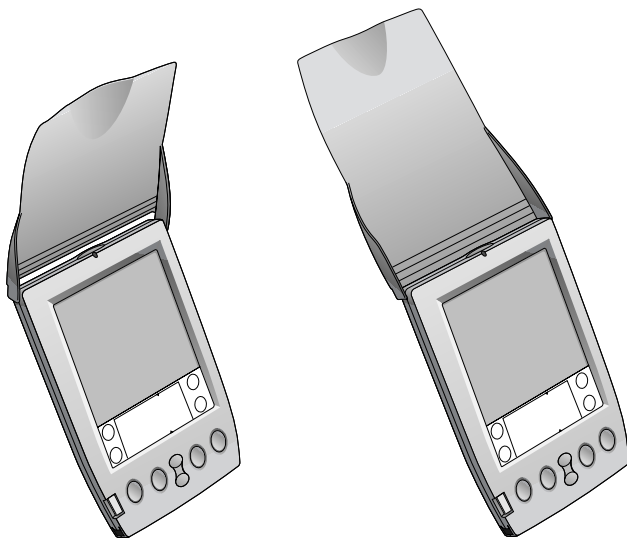



## Locating back panel components

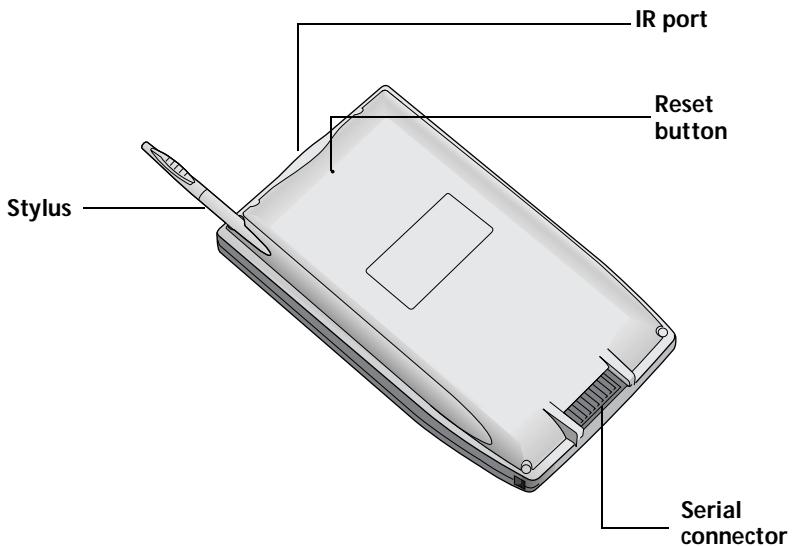

### **Stylus**

Slides in and out of the slot in the back panel of the organizer. To use the stylus, remove it from the slot and hold it as you would a pen or pencil.

### **IR port**

Uses infrared technology to transmit data to and receive data from other Palm Computing® platform handhelds, and to perform HotSync operations. See “Beaming information” in Chapter 5 and “IR HotSync operations” in Chapter 6 for more information.

### **Reset button**

Under normal use, you should not have to use the reset button. See Appendix A for information about when and how to use the reset button.

**Serial connector** Connects your organizer to the cradle, which in turn connects to the back of your computer and through the AC adapter to the wall current. This allows you to recharge your organizer as well as update the information between your organizer and computer using HotSync technology.

**Note:** The cradle must be plugged into the serial (COM) port at the back of your computer.

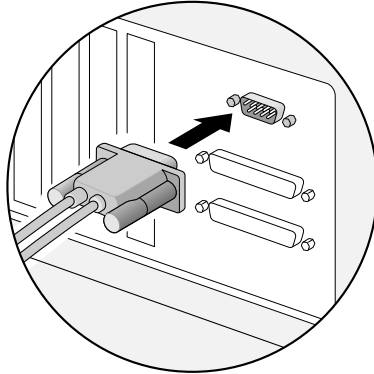

Your organizer requires a dedicated port. It cannot share a port with an internal modem or other device. If you are unsure about the exact location of the serial port on your computer, refer to the user's manual supplied with the computer.

**Important:** Only use the AC adapter that came with your organizer. Other adapters could damage your organizer and will void the warranty.

An additional connection is made from the back of the cradle's serial (COM) port connector to the AC adapter which plugs into any AC current outlet.

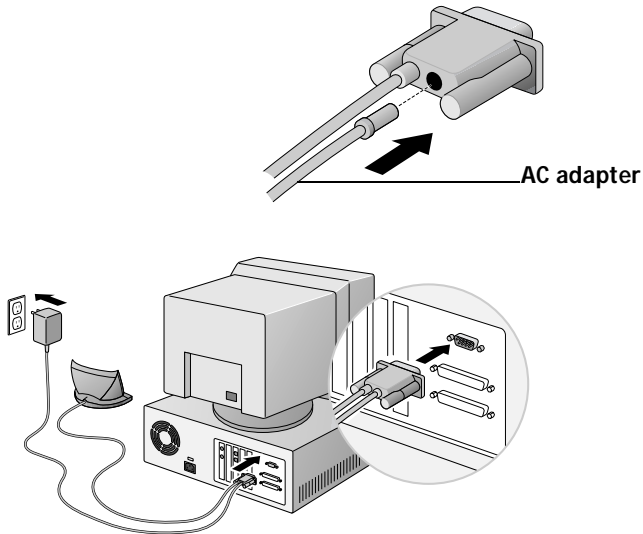

## Recharging the battery

Your organizer contains a Lithium-ion battery that is recharged each time you place the organizer in the cradle. Just place your organizer in the cradle for approximately four hours for an initial charge before you use it. Then place it in the cradle for minutes each day to recharge the battery to full capacity. A full charge will last up to two weeks with normal use. When you charge the battery, the battery icon on your organizer changes to a battery charging icon.

Battery icon



Battery charging icon



As the battery gets low, the battery icon indicates a low charge. Before the battery drains completely, perform a HotSync operation and then recharge the battery as soon as possible. If your organizer shuts down before recharging, you still have about a week to recharge the battery before you lose the data on your organizer.

### **Viewing data while in the cradle**

You can set a preference so that you can continue to view data while your organizer is in the cradle and while the battery is being recharged. See “General preferences” in Chapter 7 for more information.

**Note:** Turn your organizer off to fully recharge the battery.

### **Palm Desktop organizer software**

Palm Desktop software extends many of the functions of your organizer to your computer and serves to back up your data. Viewing and editing your data using Palm Desktop software is optional. However, when you use it with your organizer and the built-in HotSync technology, you can fully synchronize the information on your organizer with the information on your computer.

It is a good idea to back up your data in case something happens to the data on your organizer. Changes you make on your organizer or Palm Desktop software appear in both places after you synchronize.

#### **With Palm Desktop software, you can do the following:**

- Work with your organizer applications on your computer. Palm Desktop software duplicates the Date Book, Address Book, To Do List, and Memo Pad applications on your organizer, so you can view, enter, and modify any data stored on your organizer.
- Back up the data stored on your organizer with HotSync technology and synchronize the data on your Palm Desktop software. Synchronization is a one-step procedure that ensures your data is always safe and up-to-date. See “Exchanging and updating data: HotSync operations” in Chapter 4 for more information.
- Import and export data, so you can easily transfer data from other desktop applications into any of your main applications. See “Importing data” in Chapter 2 for more information.
- Print your Date Book, Address Book, To Do List, and Memo Pad information on any printer.

## Installing Palm Desktop software

The following instructions guide you through installing Palm Desktop software. After installation, refer to the online Help in Palm Desktop software for information about how to use the software.

To ensure a safe and uninterrupted installation of Palm Desktop software, please do the following before installing:

- Turn off your computer and connect the cradle to it.
- If you are installing from diskettes (rather than the CD-ROM included in the box), make sure the original Palm Desktop software diskettes are write-protected, and then make backup copies of them. When you finish, use the copies to install the software, and store the original diskettes in a safe place. Refer to your computer's manual or operating system documentation if you need information about locking or copying diskettes.
- Do *not* simply copy the Palm Desktop software files to your computer's hard disk. You must use the installer to place the files in their proper locations and to decompress the files.

### To install Palm Desktop software:

1. Exit any open programs, including those that run automatically at startup such as Microsoft Office, and disable any virus-scanning software.
2. Insert the Palm Desktop software CD-ROM into the computer's CD-ROM drive (or insert the diskette labeled Setup into the diskette drive).
3. When the Palm Desktop Installer Menu appears, click the Install button to begin the installation procedure.
4. Follow the onscreen instructions to complete the installation. During installation you will be asked to insert your organizer into the cradle.

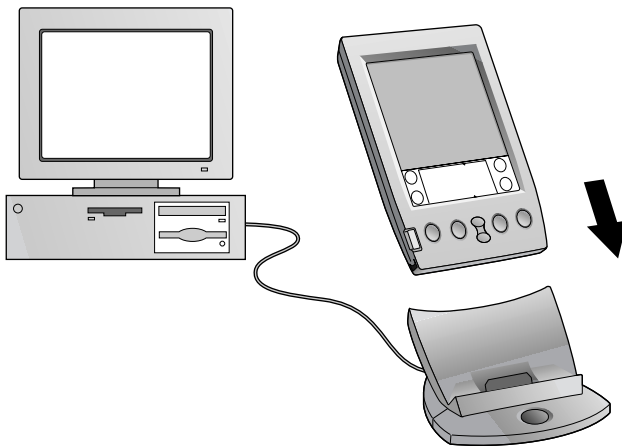

## Using your organizer with another PIM

If you prefer to use another personal information manager (PIM), such as Microsoft Outlook, you still need to install Palm Desktop software in order to add HotSync Manager, the connection software, and other features of Palm Desktop software to your computer. The connection software, called a conduit, lets you synchronize the data between your organizer and your PIM.

If the installation program detects that you have Microsoft Outlook on your computer, the program lets you choose between installing Palm Desktop software or installing the conduit for Outlook so that you can use that application as your PIM.

For information on the availability of conduit software for the PIM you use, contact the vendor of your PIM or visit the web site <http://www.palm.com>.

# Tapping and typing

## Tap with the stylus to get things done

Like using a mouse to click elements on a computer screen, using the stylus to tap elements on your organizer screen is the basic action that gets things done on your organizer.

The first time you start your organizer, setup instructions appear on the screen. These instructions include a calibration screen, or digitizer. Calibration aligns the internal circuitry of your organizer with its touch-sensitive screen so that when you tap an element on the screen, the organizer can detect exactly which task you want to perform.

**Important:** Always use the point of the stylus for tapping or making strokes on the organizer screen. Never use an actual pen, pencil, or other sharp object to write on the organizer screen.

With your organizer turned on, you can tap the organizer screen to do many operations, such as the following:

- Open applications
- Choose menu commands
- Initiate a global Find operation
- Select options in dialog boxes
- Open the onscreen keyboards



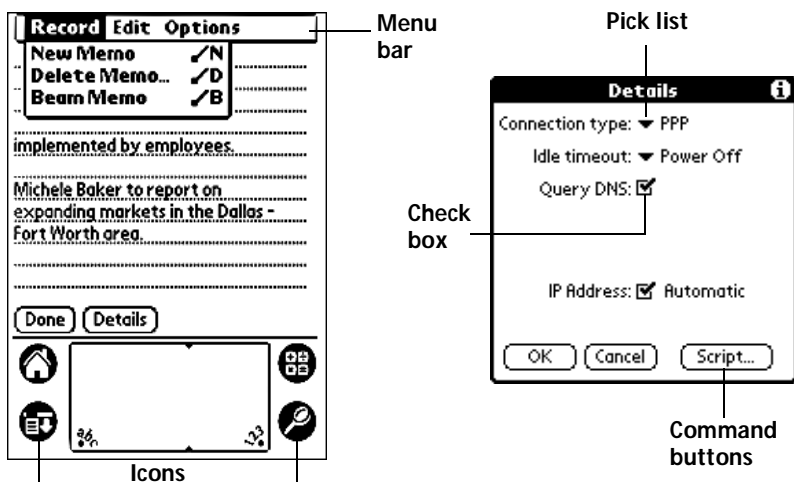

Just as you can drag the mouse to select text or move objects on your computer, you can also drag the stylus to select text. You can also use the stylus to drag the slider of any scroll bar.

## Elements of the organizer interface



**Menu bar** A set of commands that are specific to the application. Not all applications have a menu bar.

**Command buttons** Tap a button to perform a command. Command buttons appear in dialog boxes and at the bottom of application screens.

**Icons** Tap the icons to open applications , menus , Calculator , and to find text anywhere in your data .

**abc** With the cursor in an input field, tap the dot to activate the alphabetic keyboard.

**123** With the cursor in an input field, tap the dot to activate the numeric keyboard.

**Check box** When a check mark appears in a check box, the corresponding option is active. If a check box is empty, tapping it inserts a check mark. If a check box is checked, tapping it removes the check mark.

**Pick list** Tap the arrow to display a list of choices, and then tap an item in the list to select it.





Previous/next arrows

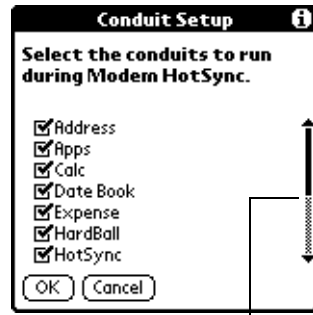

Scroll bar

**Scroll bar** Drag the slider, or tap the top or bottom arrow, to scroll the display one line at a time. To scroll to the previous page, tap the scroll bar just above the slider. To scroll to the next page, tap the scroll bar just below the slider.

You can also scroll to the previous and next pages by pressing the upper and lower portions of the scroll button on the front panel of the organizer.

**Next/previous arrows** Tap the up and down arrows to display the previous and next page of information; tap the left and right arrows to display the previous and next record.

## Opening applications

You can use the Applications Launcher to open any application installed on your organizer. You can also open the four main applications — Date Book, Address Book, To Do List, and Memo Pad — with the application buttons on the front panel of your organizer.

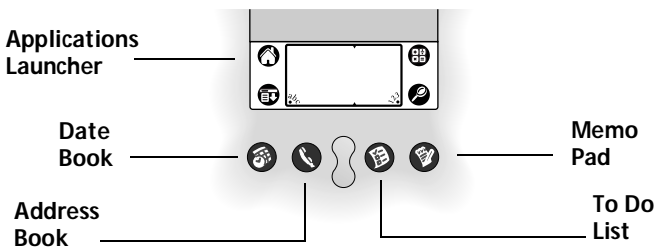

**Tip:** When you press an application button on the front panel, you have instant access to the selected application. You don't even need to turn on your organizer first.

In addition to providing a way for you to open applications, the Applications Launcher displays the current time, battery level, and application category.

**To open an application:**

1. Tap the Applications icon .



2. Tap the icon of the application that you want to open. If you have many applications installed on your organizer, tap the scroll bar to see all of your applications.

**Tip:** To find an application quickly, you can write the Graffiti character for the first letter of its name. The Applications Launcher scrolls to the first application with a name that begins with that letter. You can also assign application icons to different categories. See “Categorizing applications” in Chapter 3.

## Using menus

Menus on your organizer are easy to use. Once you have mastered them in one application, you can use them the same way in all other applications.

The menus of each application are illustrated in the section on that application in Chapter 4. The Edit menu is described in “Editing records” in Chapter 4.

To open the menu bar:

1. Open an application (such as Memo Pad).
2. Do one of the following:

Tap the Menu icon .

Tap on the inverted title area at the top of the screen.

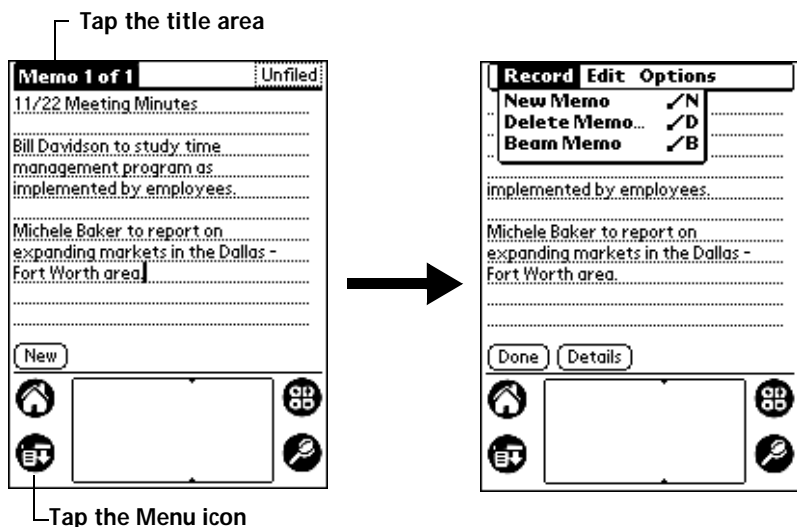

In this example, three menus are available: Record, Edit, and Options. The Record menu is selected and contains the commands New Memo, Delete Memo, and Beam Memo.

### Choosing a menu

After you open the menu bar for an application, tap the menu that contains the command you want to use.

The menus and menu commands that are available depend on the application that is currently open. Also, the menus and menu commands vary depending on *which part* of the application you're currently using. For example, in Memo Pad, the menus are different for the Memo list screen and the Memo screen.

### Graffiti menu commands

Most menu commands have an equivalent Graffiti Command stroke, which is similar to the keyboard shortcuts used to execute commands on computers. The command letters appear to the right of the command names.



Draw the Command stroke anywhere in the Graffiti area. When you draw the Command stroke, the Command toolbar appears just above the Graffiti writing area to indicate that you are in Command mode.

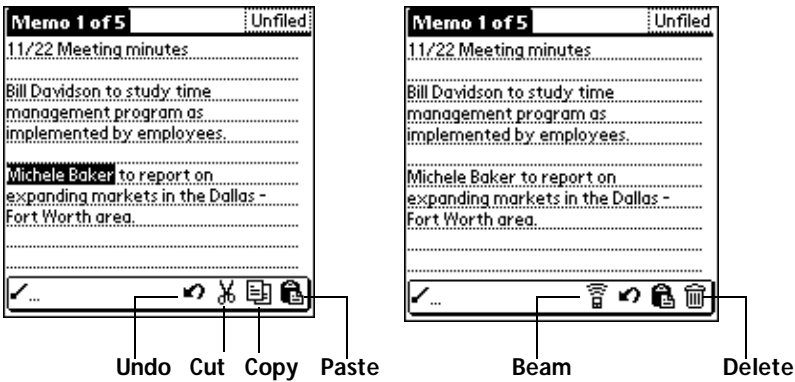

The command toolbar displays context sensitive menu commands for the current screen. For example, if text is selected the menu icons displayed may be undo, cut, copy, and paste. Tap on an icon to select the command, or immediately write the corresponding command letter for an appropriate command in the Graffiti writing area.

For example, to choose Select All in the Edit menu, draw the Command stroke, followed by the letter “s.”

**Note:** Command mode is only active for a short time, so you must tap an icon or write the command letter immediately to choose the menu command.

### Displaying online tips

Many of the dialog boxes that appear on your organizer contain an online Tips icon in the upper-right corner. Online tips anticipate questions you have in a dialog box, provide shortcuts for using the dialog box, or give you other useful information.

To display an online tip:

1. Tap the Tips icon (i).
2. After you review the tip, tap Done.

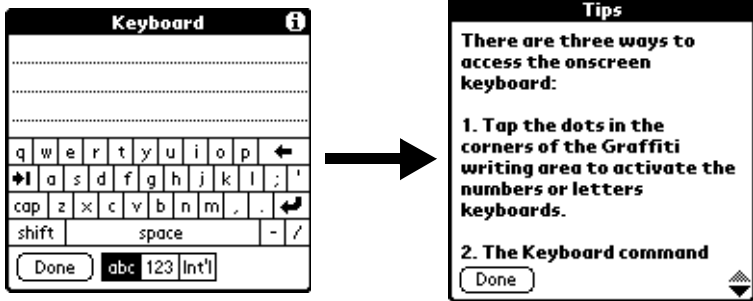

## Four ways to enter data

There are four ways to enter data into your organizer:

- Using the onscreen keyboard
- Using Graffiti writing
- Entering or importing data in Palm Desktop software and then synchronizing with your organizer
- Using an external keyboard

### Onscreen keyboard

When you create or edit a record in an application such as Address Book, you can open the onscreen alphabetic and numeric keyboards to enter data.

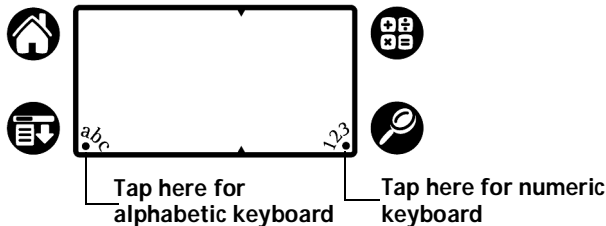

After a keyboard is open, you can tap to open any of the other keyboards, including the international keyboard. See “Using the onscreen keyboard” in Chapter 2 for more information.

**Note:** You cannot enter Graffiti characters while using the onscreen keyboard.

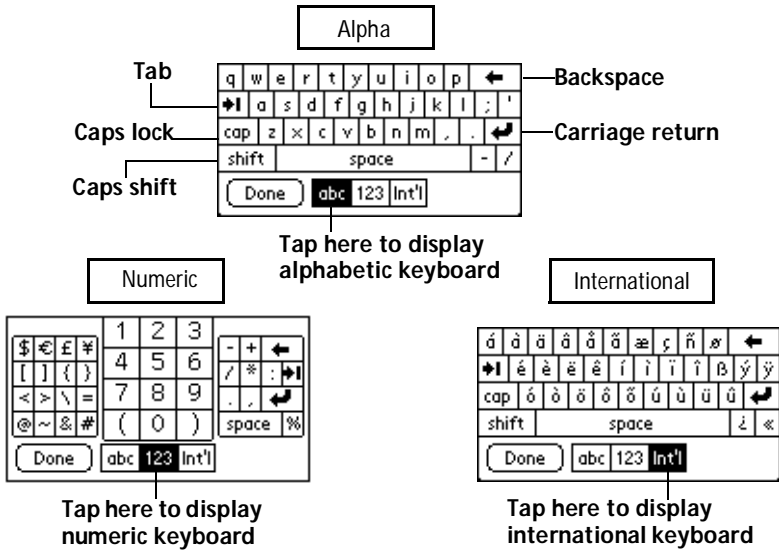

## Graffiti writing

Your organizer includes Graffiti writing software as the primary system for entering text and numbers. With Graffiti writing, you write simple strokes with the stylus and they are instantly recognized as letters or numbers.

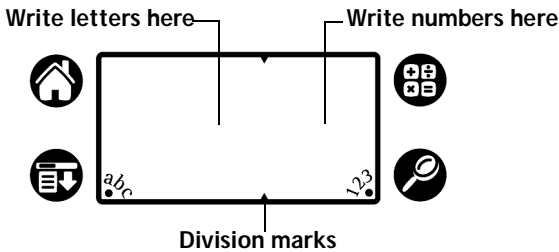

The Palm Desktop software CD-ROM includes Giraffe, a game you can use to practice Graffiti writing. See “Installing and removing applications” in Chapter 3 for installation instructions. The Memo Pad application is ideal for practicing Graffiti writing. This section explains how to open Memo Pad and use it to practice Graffiti writing.

## To open Memo Pad:

1. Press the Memo Pad application button .
2. Tap New.

**Note:** A blinking cursor appears on the first line of the new memo to indicate where new text will appear.

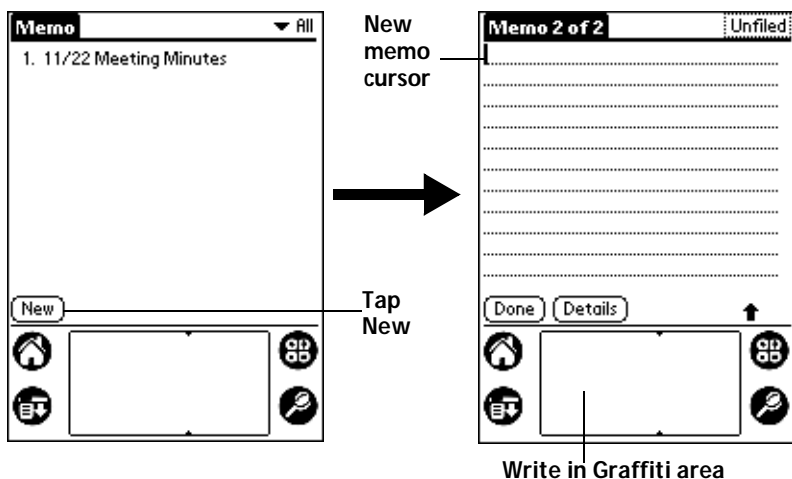

See “Using Graffiti writing to enter data” in Chapter 2 for details.

## Using Palm Desktop software

If you have new records you want to add to your organizer and prefer to use the computer keyboard rather than Graffiti writing or the onscreen keyboard, enter the data in Palm Desktop software or the PIM you have installed to use with your organizer.

After the information is in Palm Desktop software, perform a HotSync operation to synchronize your organizer with your computer. See “Exchanging and updating data: HotSync operations” in Chapter 4 for more information.

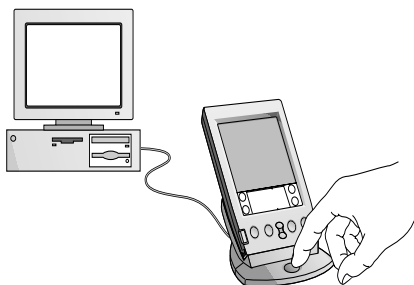

## Importing data

If you already have data in a database on your computer, you can import it into Palm Desktop software. You can import data stored in computer applications such as spreadsheets and databases, or from another Palm Computing platform handheld. When you import data, you transfer the records to your organizer without having to enter them manually. See “Importing data” in Chapter 2 for more information.



## External keyboard

You can connect an optional keyboard accessory to the serial connector on your organizer so you can type data directly into your organizer. External keyboards are very helpful when you need to enter large amounts of data quickly and accurately while you are away from your computer.

## Customizing your organizer

You can customize your organizer by using the Preferences application. You can enter personal information such as your name and address; change the time and date; view different date and time formats when you travel; turn off sounds; and configure your organizer to work with a modem or network. See Chapter 7 for more information on customizing your organizer.

To open the Preferences screens:

1. Tap the Applications icon .
2. Tap the Preferences icon .
3. Tap the category pick list in the upper-right corner of the screen.
4. Tap the Preferences category you want to view.

The following procedures for setting the time and date give you an example of how to customize your organizer.

You make changes to the time and date in General preferences.



### To set the current time:

1. Tap the Set Time box.

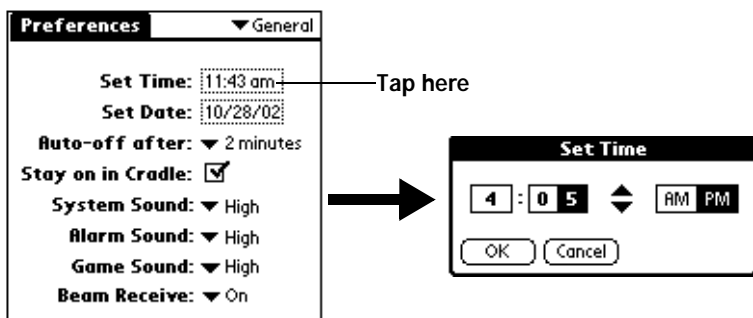

2. Tap the up or down arrows to change the hour.
3. Tap each number of the minute, and then tap the arrows to change them.
4. Tap AM or PM.

**Note:** Your organizer can also display time based on a 24-hour clock. See “Formats preferences” in Chapter 7 for more information.

5. Tap OK.

### To set the current date:

1. Tap the Set Date box.
2. Tap the arrows to select the current year.

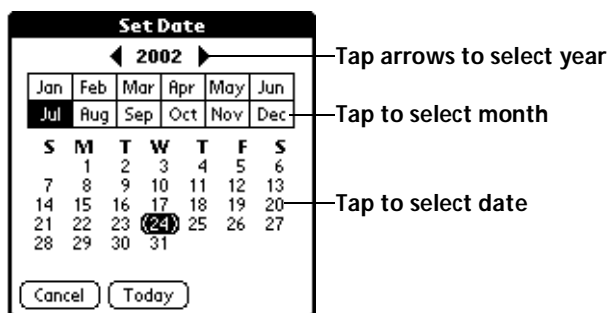

3. Tap a month.
4. Tap the current date.



## Chapter 2

# Entering Data in Your Palm IIIc™ Organizer

This chapter explains how to enter data into your Palm IIIc™ organizer by writing with the stylus in the Graffiti® writing area, by using the onscreen keyboard, by using the computer keyboard, or by importing data from another application.

## Using Graffiti writing to enter data

Chapter 1 introduced Graffiti writing and briefly described how to use it to enter text in your applications. In this section, you learn the procedures for creating letters, numbers, punctuation, and symbols, as well as some Graffiti tips and tricks.

### Writing Graffiti characters

Most people find they can enter text quickly and accurately with only minutes of practice. Graffiti writing includes any character you can type on a standard keyboard. The Graffiti strokes closely resemble the uppercase letters of the regular alphabet, which makes Graffiti writing easy to learn.

**There are four basic concepts for success with Graffiti writing:**

- If you draw the character shape exactly as shown in the tables later in this chapter (like the shapes shown in the following diagram), you achieve 100% accuracy.



- The heavy dot on each shape shows where to begin the stroke. Certain characters have similar shapes, but different beginning and end points. Always begin the stroke at the heavy dot (you should not create the heavy dot; it is only there to show you where to begin the stroke).

- Most characters require only a single stroke. When you lift the stylus from the Graffiti writing area, your organizer recognizes and displays the text character immediately. To accomplish single strokes, some Graffiti strokes are portions of the regular alphabet equivalents.
- The Graffiti writing area is divided into two parts: one for writing the letters of the alphabet and one for writing numbers. The small marks at the top and bottom of the Graffiti writing area indicate the two areas.

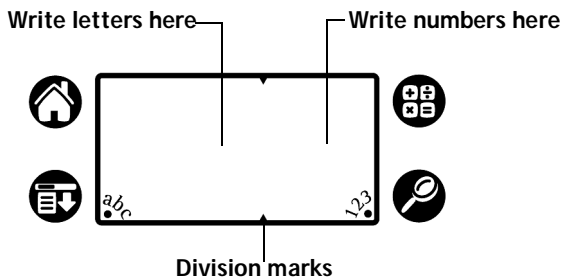

#### To write Graffiti letters:

1. Tap the screen where you want your text to go.

**Note:** You need to tap above the Graffiti writing area, and must see a blinking cursor before you write the text.

2. Use the tables on the following pages to find the stroke shape for the letter you want to create. For example, the stroke shown below creates the letter “n.”

**Note:** There are two different stroke shapes available for some letters. For these letters, choose the one that’s easiest for you.

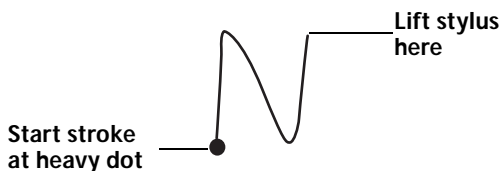

As you’ll see later, you use the same shape to create both the uppercase and lowercase version of a letter.

3. Position the stylus in the left-hand side of the Graffiti writing area.

4. Start your stroke at the heavy dot and draw the stroke shape as it appears in the tables.
5. Lift the stylus from the screen at the end of the stroke shape.

That's all there is to it! When you lift the stylus from the screen, your organizer recognizes your stroke immediately and prints the letter at the insertion point on the screen.

As soon as you lift the stylus from the screen, you can begin the stroke for the next character you want to write.

**Important:** You must begin the character strokes in the Graffiti writing area. If you do not make Graffiti strokes in the Graffiti writing area, your organizer does not recognize them as text characters.

## Graffiti tips

When using Graffiti writing, keep these tips in mind:

- Accuracy improves when you write large characters. You should draw strokes that nearly fill the Graffiti writing area.
- To delete characters, simply set the insertion point to the right of the character you want to delete and make the backspace stroke (a line from right to left) in the Graffiti writing area.
- Write at natural speed. Writing too slowly can generate recognition errors.
- Do not write on a slant. Vertical strokes should be parallel to the sides of the Graffiti writing area.
- Press firmly.

# The Graffiti alphabet

Letter	Strokes	Letter	Strokes
A		N	
B		O	
C		P	
D		Q	
E		R	
F		S	
G		T	
H		U	
I		V	
J		W	
K		X	
L		Y	
M		Z	
Space		Back Space	
Carriage Return		Period	<i>tap twice</i>

## Writing capital letters

You make capital letters with the same stroke shapes as the basic alphabet characters. To make capital letters, you must first “shift” to caps — just as you press the Shift key on a keyboard — and then write the character strokes.

**Note:** Graffiti writing includes a feature that automatically capitalizes the first letter when you create a new sentence or a new record (by tapping New or a blank line).

**To draw the first letter of a word as a capital letter:**

- Use the Caps Shift stroke:

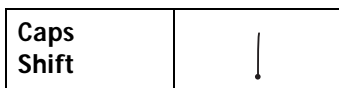

**Tip:** When Caps Shift is active, an “up arrow” symbol appears in the lower-right corner of the organizer screen. If you accidentally activate Caps Shift, backspace will cancel it.

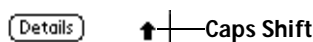

**To enter only capital letters (Caps Lock):**

- Use the Caps Lock stroke:





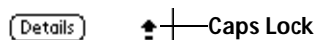







**Tip:** When Caps Lock is active, an underlined “up arrow” symbol appears in the lower-right corner of the organizer screen. To return to lowercase, make the Caps Shift stroke.



## Writing numbers

Writing numbers with Graffiti writing is similar to writing letters of the alphabet, except that you make the character strokes on the right-hand side (numbers side) of the Graffiti writing area.

## Graffiti numbers

Number	Strokes	Number	Strokes
0		5	
1		6	
2		7	
3		8	
4		9	

## Writing punctuation marks

Graffiti writing can create any punctuation symbol that you can enter from a standard keyboard. All punctuation marks begin with a single tap on the Graffiti writing area. When you make this tap, you activate Punctuation Shift and a dot appears to show it is active. The next stroke you make with the stylus creates a punctuation mark.

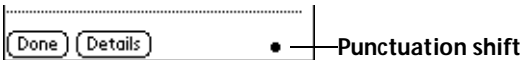

**Note:** When Punctuation Shift is active, you can make a symbol stroke anywhere in the Graffiti writing area (the letters or numbers side).



Symbol	Stroke	Symbol	Stroke
Period .	•	Dash —	—
Comma ,	,	Left Paren (	(
Apostrophe '	'	Right Paren )	)
Question ?	?	Slash /	/
Exclamation !	!	Dollar \$	\$

### Additional Graffiti punctuation

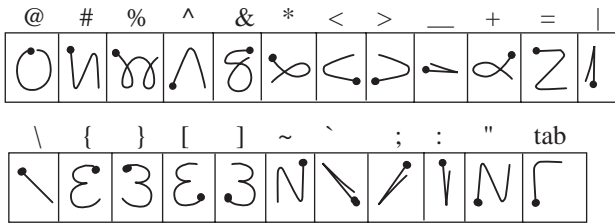

### Writing symbols and extended characters

All symbols and extended characters begin with the stroke in the Graffiti writing area of your organizer:

Symbol Shift	
-----------------	--

When the Symbol Shift is active, a slanted shift symbol appears in the lower-right corner of the screen. The next stroke that you make creates the symbol or extended character.

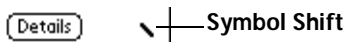

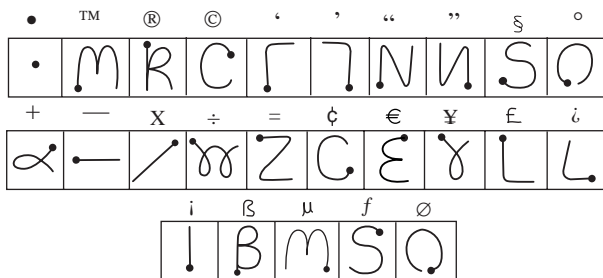

## Writing accented characters

To create accented characters, draw the stroke normally used to create the letter, followed by an accent stroke. Graffiti writing then adds the accent to the letter.

For example, the following diagram shows the strokes required to draw an accented “e.”

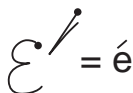

## Accent strokes

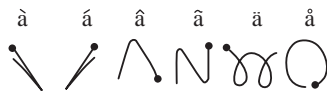

Using these accent strokes, you can write the following accented letters:

à á â ã ä å è é ê ì í î ï ò ó ô õ ö ù ú û ü ý ÿ ñ

## Additional non-English characters



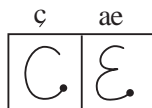

You can write the following characters without any special punctuation or shifting:



**Note:** You must write these non-English characters in the left side of the Graffiti writing area.

## Navigation strokes

In addition to character symbols, Graffiti writing includes special strokes that you can use to navigate within text or fields in your applications.

Command	Stroke
Move cursor right	
Move cursor left	
Previous field (Address Book only)	
Next Field (Address Book only)	
Open Address Record (Address Book only)	

## Graffiti ShortCuts

Graffiti ShortCuts make entering commonly used words or phrases quick and easy. ShortCuts are similar to the Glossary or Autotext features of some word processors.

Graffiti writing comes with several predefined ShortCuts, and you can also create your own. Each ShortCut can represent up to 45 characters. For example, you might create a ShortCut for your name, or for the header of a memo. See “ShortCuts preferences” in Chapter 7 to learn about creating your own ShortCuts.

To use a ShortCut, draw the ShortCut stroke followed by the ShortCut characters. When you draw the ShortCut stroke, the ShortCut symbol appears at the insertion point to show that you are in ShortCut mode.

ShortCut	
----------	---

Your organizer includes the following predefined Graffiti ShortCuts:

Entry	ShortCut
Date stamp	<b>ds</b>
Time stamp	<b>ts</b>
Date / time stamp	<b>dts</b>
Meeting	<b>me</b>
Breakfast	<b>br</b>
Lunch	<b>lu</b>
Dinner	<b>di</b>

## Using the onscreen keyboard

You can open the onscreen keyboard anytime you need to enter text or numbers on your organizer. Note that you cannot enter Graffiti characters while using the onscreen keyboard.

**To use the onscreen keyboard:**

1. Open any application (such as Memo Pad).
2. Tap any record, or tap New.
3. Tap “abc” to open the alphabetic keyboard, or tap “123” to open the numeric keyboard.

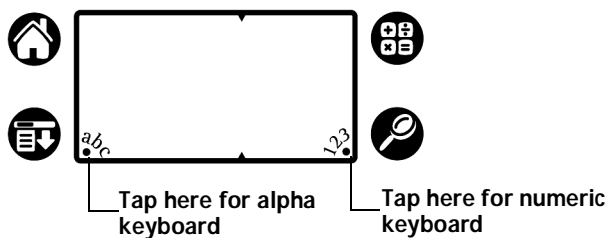

4. Tap the characters to enter text and numbers.

**Note:** The onscreen keyboard also includes a dialog box for international characters. You can switch among the three dialogs at any time to enter the exact text you need.

5. After you finish, tap Done to close the onscreen keyboard and place the text in the record.

## Using your computer keyboard

If you have a lot of data to enter, or prefer to use the computer keyboard, you can use Palm™ Desktop software or any supported PIM to enter information. You can then perform a HotSync® operation to synchronize the information on your computer with the information on your organizer. All the main applications on your organizer are also available in Palm Desktop software and in most PIMs, so you don't need to learn different applications.

Refer to Palm Desktop online Help for more information on entering data on your computer.

## Importing data

If you have data stored in computer applications such as spreadsheets and databases, or if you want to import data from another organizer, you can transfer the data to your organizer without having to key it in manually. Save the data in one of the file formats listed below, import it into Palm Desktop software, and then perform a HotSync operation to transfer the data to your organizer.

Palm Desktop software can import data in the following file formats:

- Comma delimited (.csv, .txt): Address Book and Memo Pad only
- Tab delimited (.tab, .tsv, .txt): Address Book and Memo Pad only
- CSV (Lotus Organizer 2.x/97 Mapping): Address Book only
- Date Book archive (.dba)
- Address Book archive (.aba)
- To Do archive (.tda)
- Memo Pad archive (.mpa)

Archive formats can only be used with Palm Desktop software. Use the archive file formats to share information with other people who use a Palm Computing® platform handheld or to create a copy of your important Palm Desktop information.

### To import data:

1. Open Palm Desktop software.
2. Click the application into which you want to import data.
3. If you are importing records that contain a field with category names, do the following:

Select All in the Category box.

Be sure that the same categories that appear in the imported file also exist in the application. If the categories do not exist, create them now; otherwise, the records are imported into the Unfiled category.

4. From the File menu, choose Import.
5. Select the file you want to import.
6. Click Open.
7. To import data into the correct Palm Desktop fields, drag fields in the left-hand column so that they are opposite the corresponding imported field on the right.
8. If you do not want to import a field, deselect the check box for that field.
9. Click OK.

The imported data is highlighted in the application.

10. To add the imported data to your organizer, perform a HotSync operation.

See Palm Desktop online Help for more information on importing and exporting data.

## Chapter 3

# Managing Your Applications

This chapter explains how to switch between applications on your Palm IIIc™ organizer, how to change application settings so they are personalized to your work methods, and how to categorize applications so you view them in related groups.

## Using the Applications Launcher

To open the Applications Launcher, tap the Applications icon .

### Selecting applications

Your organizer is equipped with a variety of applications. All the applications installed on your organizer appear in the Applications Launcher. See “Opening applications” in Chapter 1 for details.



### Switching between applications

When working in any application, tap the Applications icon  or press an application button on the front panel of your organizer to switch to another application. Your organizer automatically saves your work in the current application and displays it when you return to that application.

### Categorizing applications

The category feature enables you to manage the number of application icons that appear onscreen in the Applications Launcher. You can assign an application to a category and then display a single category or all your applications.

To categorize an application:

1. Tap the Applications icon .
2. Tap the Menu icon .
3. Tap App, and then tap Category.
4. Tap the pick list next to each application to select a category.



**Tip:** To create a new category, tap Edit Categories from the pick list. Tap New, enter the category name, and then tap OK to add the category. Tap OK.

5. Tap Done.

To display applications by category:

1. Tap the Applications icon .
2. Do one of the following:

Tap the Applications icon repeatedly to cycle through all your categories.



Tap the pick list in the upper-right corner of the screen and select the category you want to display.

## Changing the Applications Launcher display

By default, the Applications Launcher displays each application as an icon. As an alternative, you can choose to show a list of applications. You can also choose to view the same category of applications each time you open the Applications Launcher.





To change the Applications Launcher display:

1. Tap the Applications icon .
2. Tap the Menu icon .
3. Tap Options, and then tap Preferences.
4. Tap the View By pick list and select List.
5. Tap OK.



To open the Applications Launcher to the last opened category:

1. Tap the Applications icon .
2. Tap the Menu icon .
3. Tap Options, and then tap Preferences.
4. Tap the Remember Last Category check box to select it.
5. Tap OK.

## Choosing preferences

You can set options that affect an entire application in the application's Preferences dialog box.

To change preferences for an application:

1. Open an application.
2. Tap the Menu icon .
3. Tap Options, and then tap Preferences.

**Note:** Not all applications have a Preferences command.

4. Make changes to the settings.
5. Tap OK.

# Installing and removing applications

This section explains how to install and remove applications on your organizer and how to remove Palm™ Desktop software from your computer.

## Installing add-on applications

Your organizer comes with the Date Book, Address Book, To Do List, Memo Pad, Expense, Calculator, and Mail applications installed and ready to use.

You can also install additional applications on your organizer, such as games and other software. The Install Tool makes it easy to install software on your organizer during a HotSync® operation. There are a variety of third-party applications available for your organizer. To learn more about these applications, go to the web site:

<http://www.palm.com>.

**Note:** Any game or application that you install on your organizer resides in RAM memory; you can delete them at any time.

### To install add-on software on your organizer:

1. On your computer, copy or download the application you want to install into the add-on folder in your Palm Desktop directory on your computer.

**Note:** If the software you download is compressed, you need to decompress it into this folder. If you prefer to place the application into another folder, you need to navigate to that folder before you complete step 5.

2. Double-click the Palm Desktop icon on your desktop.

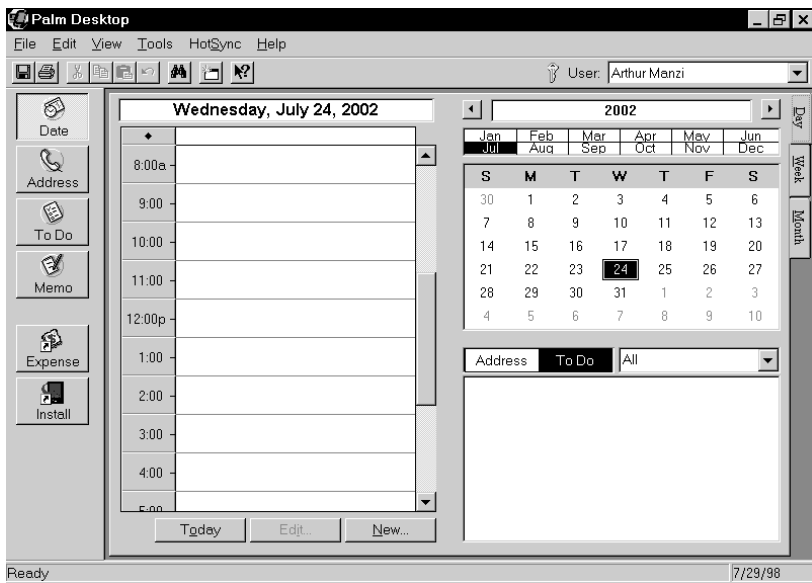

### 3. Click Install.

**Tip:** You can also access the Install Tool dialog by selecting Install Tool from the Palm Desktop program group or by double-clicking any file with a PRC, PDB, or PNC file extension.

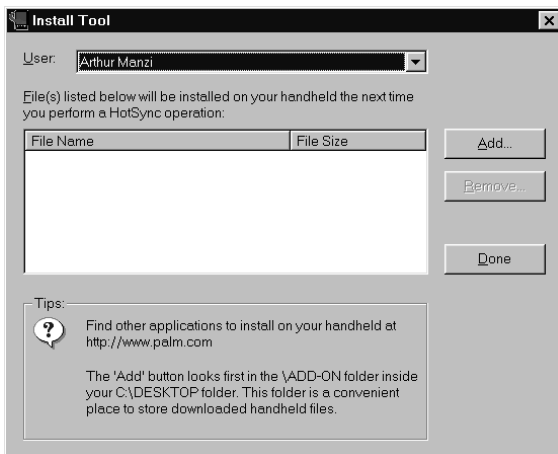

- In the User drop-down list, select the name that corresponds to your organizer.
- Click Add.

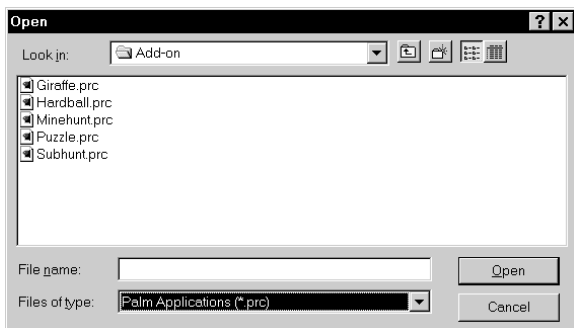

- Select the application(s) that you want to install on your organizer.
- Click Open.

**Note:** Review the list of applications you selected in the Install Tool dialog box. If you do not want to install an application, select it, and then click Remove. (This does not remove the application from your computer; it simply removes it from the list of applications to install.)

- Perform a HotSync operation to install the application(s) you selected in step 6. See “Exchanging and updating data: HotSync operations” in Chapter 4 for details.

## Installing games



The CD-ROM also includes games that you can install with the Install Tool, such as Giraffe. Giraffe is a fun, easy way for you to practice Graffiti® writing.

After you install and start a game, the instructions appear in the Game menu. Depending on the game, the Game menu may also contain commands to show high scores, to start a new game, or to set preferences for the game.

## Removing applications

In the event that you run out of memory or decide that you no longer need an application you installed, you can remove applications from your organizer. You can remove only add-on applications, patches, and extensions that you install; you cannot remove the applications that reside in the ROM portion of your organizer.

To remove an add-on application:

1. Tap the Applications icon .
2. Tap the Menu icon .
3. Tap App, and then tap Delete.
4. Tap the application that you want to remove.



5. Tap Delete.
6. Tap Yes.
7. Tap Done.

## Removing Palm Desktop software

If you no longer want to use Palm Desktop software, you can remove it from your computer.

To remove Palm Desktop software:

1. From the Windows Start menu, choose Settings, and then Control Panel.
2. Double-click the Add/Remove Programs icon.
3. On the Install/Uninstall tab, select Palm Desktop software.
4. Click Add/Remove.

**Note:** You need to install the HotSync Manager from the installation CD if you want to synchronize data with another PIM.

# Security

Your organizer comes with a Security application so that unauthorized users cannot view the entries you wish to protect.

## In Security, you can do the following:

- Lock and turn off your organizer so that it does not operate until you enter the correct password.
- Mask all records that you mark as private so the information appears greyed out.
- Hide all records that you mark as private so they do not appear on any screen.

You can mask and hide private records with or without a password. Without a password, private records are hidden or masked until you set the Security application to show them. With a password, you must enter the password to view the private entries. See “Making records private” in Chapter 4 for information on making records private.

## Assigning a password

You can assign a password to protect your private records and to lock your organizer.

### To assign a password:

1. Tap the Applications icon .
2. Tap the Security icon.
3. Tap the Password box.
4. Enter a password.

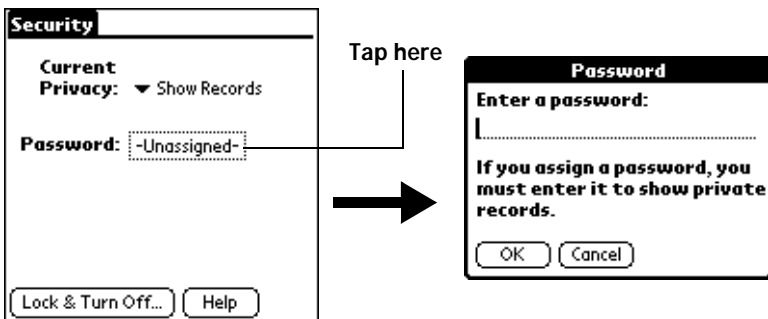

5. Tap OK.
6. Enter the *same* password a second time, and tap OK.

## Changing or deleting a password

Once you define a password for your organizer, you can change or delete it at any time. You must enter the current password before you can change or delete it.

To change or delete your password:

1. Tap the Password box.
2. Enter the current password.

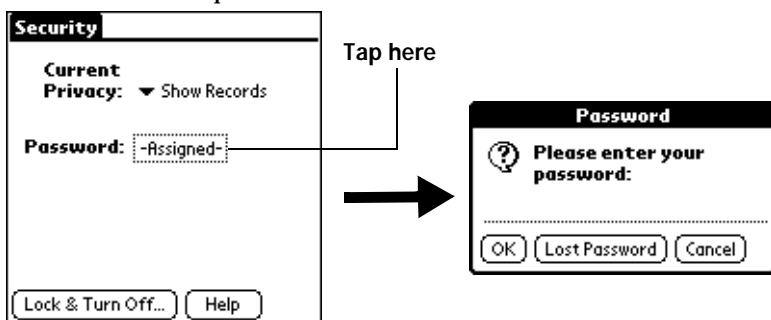

3. Tap OK.
4. Do one of the following:
  - To change the password, enter the new password, and tap OK.
  - To delete the password, tap Delete.



## Locking your organizer

You can also lock your organizer so that you need to enter your password to operate it.

**Important:** If you lock your organizer, you must enter the exact password to re-activate your organizer. If you forget the password, you must perform a hard reset to resume using your organizer. Performing a hard reset deletes all the records in your organizer; however, you can restore all synchronized data at the next HotSync operation. See “Resetting your organizer” in Appendix A for more information.

### To lock your organizer with a password:

1. Perform a HotSync operation to synchronize the data between your organizer and your computer. See “Exchanging and updating data: HotSync operations” in Chapter 4 for information on synchronizing your data.
2. Assign a password.
3. Tap Lock & Turn Off.

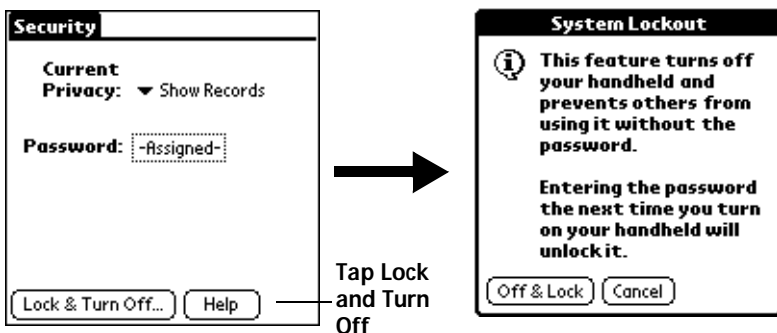

4. Tap Off & Lock.
5. To start your organizer, turn it on and then enter the password.

## Recovering from a forgotten password

If you did not activate the Off & Lock feature and you forget your password, you can delete the password from your organizer. Deleting a forgotten password also deletes all entries and files marked as Private.

**Important:** If you synchronize with your computer before deleting a forgotten password, your organizer restores your private entries the next time you perform a HotSync operation, but it does not restore the password.

### To delete a forgotten password:

1. Tap Lost Password.
2. Tap Yes.



## Chapter 4

# Using Your Basic Applications

Your Palm IIIc™ organizer includes these basic applications:

- Date Book
- Address Book
- To Do List
- Memo Pad
- Calculator
- Expense

This chapter is divided into three sections:

- “Overview of basic applications” briefly describes each application and explains how to open it.
- “Common tasks” gives instructions on how to do tasks that you can do in most or all of the basic applications. It’s easy to transfer what you learn in one application to the others because the structure and behavior of all the applications are quite similar.
- “Application-specific tasks” is organized by application and gives instructions on how to do tasks that are specific to each application.

# Overview of basic applications

## Date Book



Date Book lets you quickly and easily schedule appointments or any kind of activity associated with a time and date.

### In Date Book, you can do the following:

- Enter a description of your appointment and assign it to a specific time and date.
- Display a chart of your appointments for an entire week. The Week View makes it easy to spot available times and any potential scheduling overlaps or conflicts.
- Display a monthly calendar to quickly spot days where you have morning, lunch, or afternoon appointments.
- Display an agenda showing appointments, untimed events, and your To Do items for the day.
- Set an alarm to sound prior to the scheduled activity.
- Create reminders for events that are based on a particular date, rather than time of day. Birthdays and anniversaries are easy to track with your organizer.
- Attach notes to individual events for a description or clarification of the entry in your Date Book.

### To open Date Book:

- Press the Date Book application button on the front panel of your organizer. Date Book opens to today's schedule.

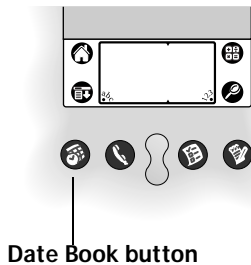

**Note:** Press the Date Book application button repeatedly to cycle through the Day, Week, Month and Agenda views.

# Address Book



Address Book enables you to keep names, addresses, phone numbers, and other information about your personal or business contacts.

## In Address Book, you can do the following:

- Quickly look up or enter names, addresses, phone numbers, and other information.
- Enter up to five phone numbers (home, work, fax, car, etc.) or e-mail addresses for each name.
- Define which phone number appears in the Address list for each Address Book entry.
- Attach a note to each Address Book entry, in which you can enter additional information about the entry.
- Assign Address Book entries to categories so that you can organize and view them in logical groups.

## To open Address Book:

- Press the Address Book application button on the front panel of your organizer. Address Book opens to display the list of all your records.

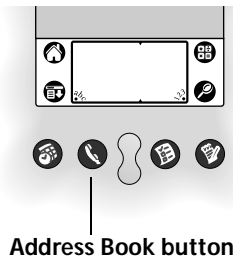

**Note:** Press the Address Book application button repeatedly to cycle through the categories in which you have records.

## To Do List



To Do List is a convenient place to create reminders and prioritize the things that you have to do.

### In To Do List, you can do the following:

- Make a quick and convenient list of things to do.
- Assign a priority level to each task.
- Assign a due date for any or all of your To Do List items.
- Assign To Do List items to categories so that you can organize and view them in logical groups.
- Sort your To Do List items either by due date, priority level, or category.
- Attach notes to individual To Do List items for a description or clarification of the task.

### To open To Do List:

- Press the To Do List application button on the front panel of your organizer. To Do List opens to display the category of items you last viewed.

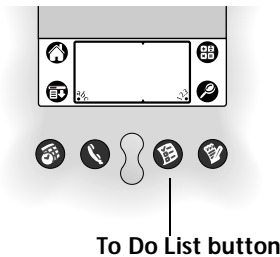

**Note:** Press the To Do List application button repeatedly to cycle through the categories in which you have items.

## Memo Pad



Memo Pad provides a place to take notes that are not associated with records in Date Book, Address Book, or To Do List.

### In Memo Pad, you can do the following:

- Take notes or write any kind of message on your organizer.
- Drag and drop memos into popular computer applications like Microsoft Word when you synchronize using Palm™ Desktop software and HotSync® technology.
- Assign memos to categories so that you can organize and view them in logical groups.
- Write down phone numbers and other types of information. Later, you can copy and paste this information to other applications.

### To open Memo Pad:

- Press the Memo Pad application button on the front panel of your organizer. Memo Pad opens to display the last Memo Pad screen that you viewed.

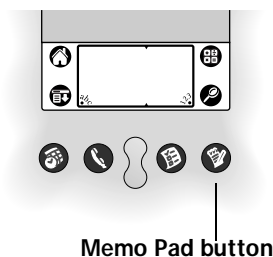

**Note:** Press the Memo Pad application button repeatedly to cycle through the categories in which you have memos.

## Calculator



Calculator enables you to perform addition, subtraction, multiplication, and division.

### In Calculator, you can do the following:

- Perform basic calculations.
- Store and retrieve values.
- Display the last series of calculations, which is useful for confirming a series of “chain” calculations.

To open Calculator:

- Tap the Calculator icon  next to the Graffiti® writing area.

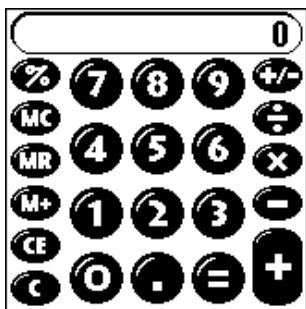

## Expense





Expense lets you keep track of your expenses and then transfer the information to a spreadsheet on your computer.

**In Expense, you can do the following:**

- Record dates, types of expenses, amount spent, payment method, and other details associated with any money that you spend.
- Assign expense items to categories so that you can organize and view them in logical groups.
- Keep track of vendors (companies) and people involved with each particular expense.
- Log miles traveled for a particular date or expense category.
- Sort your expenses by date or expense type.
- Transfer your expense information to a Microsoft Excel spreadsheet (version 5.0 or later) on your computer. (Microsoft Excel is *not* included in the Palm IIIc organizer package.)

To open Expense:

1. Tap the Applications icon .
2. Tap the Expense icon .

## Common tasks

The tasks described in this section use the term “records” to refer to an individual item in any of the basic applications: a single Date Book event, Address Book entry, To Do List item, Memo Pad memo, or Expense item.

### Creating records

You can use the following procedure to create a new record in Date Book, Address Book, To Do List, Memo Pad, and Expense.

**To create a record:**

1. Select the application in which you want to create a record.
2. Tap New.
3. In Date Book only: Select start and end times for your appointment and tap OK.
4. Enter text for the record.
5. (Optional) Tap Details to select attributes for the record.
6. In Address Book and Memo Pad only: Tap Done.

There’s no need to save the record because your organizer saves it automatically.

### Editing records

After you create a record, you can change, delete, or enter new text at any time. Two screen features tell you when your organizer is in editing mode:

- A blinking cursor
- One or more edit lines

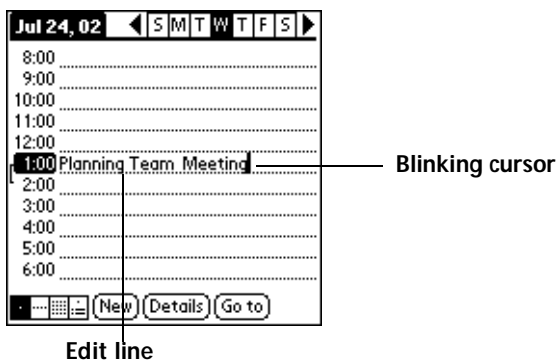

## Entering text

For information on how to enter text using Graffiti writing, the onscreen keyboard, or the keyboard attached to your computer, see Chapter 2.

## Edit menu

The Edit menu is available with any screen where you enter or edit text. In general, commands available in the Edit menu apply to text that you *select* in an application.

### To select text in an application:

1. Tap the beginning of the text that you want to select.
2. Drag the stylus over the text to highlight it (in black).

**Note:** You can also double tap to select a word, or triple tap to select a line of text.

You can also drag *across* the text to select additional words, or drag *down* to select a group of lines.

The following commands may appear in an Edit menu:

<b>Undo</b>	Reverses the action of the <i>last edit</i> command. For example, if you used Cut to remove text, Undo restores the text you removed. Undo also reverses deletions done by using backspace.
<b>Cut</b>	Removes the selected text and stores it temporarily in the memory of your organizer. You can paste the text you cut into another area of the current application or into a different application.
<b>Copy</b>	Copies the selected text and stores it temporarily in the memory of your organizer. You can paste the text that you copy into another area of the current application or into a different application.
<b>Paste</b>	Inserts the text that you cut or copied at the selected point in a record. The text you paste replaces any selected text. If you did not previously cut or copy text, Paste does nothing.



<b>Select All</b>	Selects all of the text in the current record or screen. This enables you to cut or copy all of the text and paste it elsewhere.
<b>Keyboard</b>	Opens the onscreen keyboard. When you finish with the onscreen keyboard, tap Done.
<b>Graffiti Help</b>	Opens screens that show all the Graffiti character strokes. Use this command anytime you forget a stroke for a character.

## Deleting records

To delete a record in any of the basic applications:

1. Select the record you want to delete.
2. Tap the Menu icon .
3. Tap Record, and then tap the Delete command:

Date Book: Delete Event

Address Book: Delete Address

To Do List: Delete Item

Memo Pad: Delete Memo

Expense: Delete Item

A confirmation dialog box appears. If you want to save a copy of the deleted item to an archive file in Palm Desktop software, be sure that the check box is checked. If you don't want to save a copy, tap the check box to remove the check.

4. Tap OK.

If you choose to save a copy of the selected item, your organizer transfers it to the archive file on your desktop the next time you perform a HotSync operation.

### Other ways to delete records

You can also delete records in the following ways:

- In the Details dialog box of the application, tap Delete, and then tap OK.
- Delete the text of the record.

**Note:** In Date Book, you can choose to delete the text of the current repeating event, current and future events, or all instances of that event.

## Purging records

Over time, as you use Date Book, To Do List, and Expense, you'll accumulate records in these applications that have outlived their usefulness. For example, events that occurred months ago remain in the Date Book, and To Do List items that you marked as completed remain in the list, as do Expense items.

All these outdated records take up memory on your organizer, so it's a good idea to remove them by using Purge. If you think Date Book or To Do List records might prove useful later, you can purge them from your organizer and save them in an archive file.

Purging is also available in Mail. See Chapter 5 for more information.

Purging is not available in Address Book or Memo Pad, so delete outdated records from these applications.

### To purge records:

1. Open the application.
2. Tap the Menu icon .
3. Tap Record, and then tap Purge.

A confirmation dialog box appears.

**Date Book:** Tap the pick list and select how old a record must be to be purged. Purge deletes repeating events if the last of the series ends before the date that you purge records.

**Date Book, To Do List:** If you want to save a copy of the purged records to an archive file on your desktop, be sure that the check box is checked. If you don't want to save a copy, tap the check box to remove the check box.

4. Tap OK.

If you chose to save a copy of the purged records, your organizer transfers them to an archive file on your desktop the next time you perform a HotSync operation.

**Note:** Purging does not happen automatically. You must tap the command to make it happen.

## Exchanging and updating data: HotSync operations

The HotSync process automatically synchronizes — that is, exchanges and updates — data between your organizer and Palm Desktop software. Changes you make on your organizer or Palm Desktop

software appear in both places after a HotSync operation. HotSync technology synchronizes only the needed portions of files, thus reducing synchronization time.

You can synchronize your data either directly or indirectly. Direct methods include placing your organizer in the cradle attached to your computer, or using infrared communications. Indirect methods include using a modem, or via a network using the network HotSync technology. See Chapter 6 for information about performing HotSync operations via a modem, network, or IR port.

### Performing a HotSync operation for the first time

The first time you synchronize your data, you need to enter user information on both the organizer and Palm Desktop software. After you enter this information and synchronize, the HotSync Manager recognizes your organizer and doesn't ask for this information again.

If you are a System Administrator preparing several connected organizers for a group of users, you may want to create a user profile. See "Creating a user profile" in Chapter 6 before performing the following steps.

**Important:** You must perform your *first* HotSync operation with a local, direct connection, rather than using a modem.

The following steps assume that you have already installed the Palm Desktop software. If you have not installed this software, see "Installing Palm Desktop software" in Chapter 1 for instructions.

To perform a local HotSync operation:

1. Insert your organizer into the cradle.

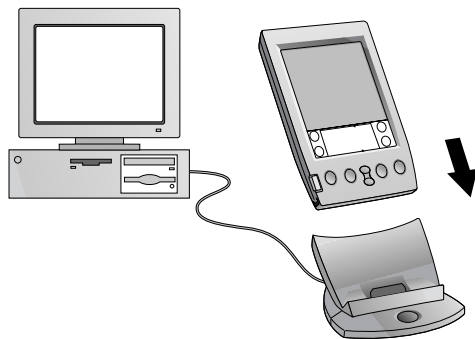

**Tip:** The bottom edge of the organizer should align smoothly with the cradle when it is inserted properly.

2. If the HotSync Manager is not running, start it: On the Windows desktop, click Start, and then choose Programs. Navigate to the Palm Desktop software program group and choose HotSync Manager. Alternatively, you can start the Palm Desktop software which automatically opens the HotSync Manager.
3. Press the HotSync button ™ on the cradle.

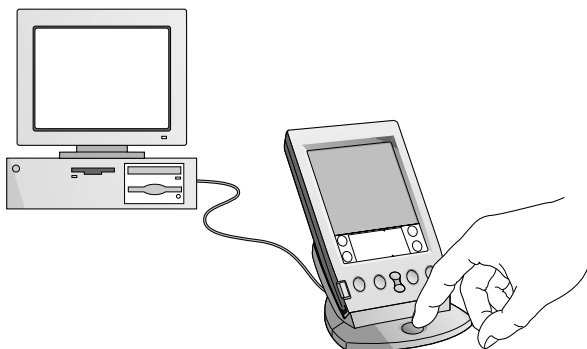

**Important:** The first time you perform a HotSync operation, you must enter a user name in the New User dialog box and click OK. Every organizer should have a unique name. To prevent loss of a user's records, never try to synchronize more than one organizer to the same user name.

The HotSync Progress dialog box appears and synchronization begins.

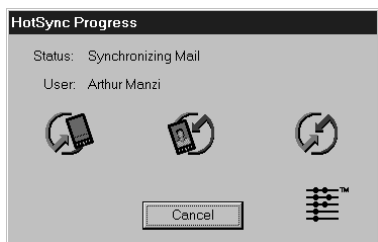

4. Wait for a message on your organizer indicating that the process is complete.

After the HotSync process is complete, you can remove your organizer from the cradle.

## Categorizing records

Categorize records in the Address Book, To Do List, Memo Pad, and Expense applications so that they are grouped logically and are easy to review. (You can also categorize applications. See “Using the Applications Launcher” in Chapter 3 for more information.)

When you create a record, your organizer automatically places it in the category that is currently displayed. If the category is All, your organizer assigns it to the Unfiled category. You can leave an entry as Unfiled or assign it to a category at any time.

### System-defined and user-defined categories

By default, your organizer includes system-defined categories, such as All and Unfiled, and user-defined categories, such as Business and Personal.

You cannot modify the system-defined categories, but you can rename and delete the user-defined categories. In addition, you can create your own user-defined categories. You can have a maximum of 15 user-defined categories in each application.

Address Book contains the QuickList user-defined category, in which you can store the names, addresses, and phone numbers you might need in emergencies (doctor, fire department, lawyer, etc.).

Expense contains two user-defined categories, New York and Paris, to show how you might sort your expenses according to different business trips.

**Note:** The illustrations in this section come from Address Book, but you can use these procedures in all the applications in which categories are available.

#### To move a record into a category:

1. Select the record you want to categorize.
2. In Address Book only: Tap Edit.
3. Tap Details.
4. Tap the Category pick list to display the list of available categories.



5. Select the category for the record.
6. Tap OK.

**Note:** In Address Edit and Memo you can tap the category name in the upper-right corner of the screen and select a new category for the item.

**To display a category of records:**

1. Tap the category pick list in the upper-right corner of the list screen.

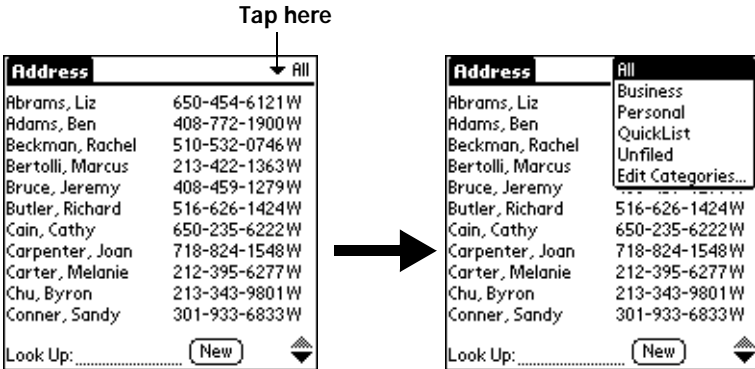

**Note:** In the Date Book Agenda view, the pick list is in the upper right of the To Do list.

2. Select the category you want to view.

The list screen now displays only the records assigned to that category.

**Tip:** Pressing an application button on the front panel of the organizer toggles through all the categories of that application.

To define a new category:

1. Tap the category pick list in the upper-right corner of the screen or list.

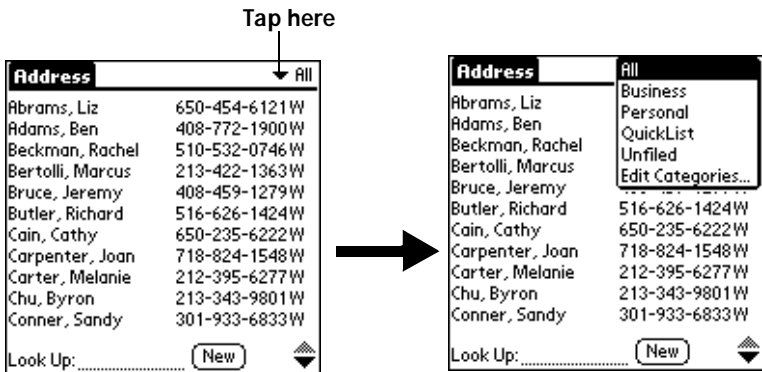

2. Tap Edit Categories.
3. Tap New.



4. Enter the name of the new category, and then tap OK.



5. Tap OK.

You can assign any of your records to the new category.

### To rename a category:

1. Tap the category pick list in the upper-right corner of the screen or list.
2. Tap Edit Categories.
3. Select the category that you want to rename, and then tap Rename.



4. Enter the new name for the category, and then tap OK.



5. Tap OK.

**Tip:** You can group the records in two or more categories into one category by giving the categories the same name. For example, if you change the name of the Personal category to Business, all records formerly in the Personal category appear in the Business category.

## Finding records

Your organizer offers several ways to find information quickly:

- All applications: Find locates any text that you specify, always starting with the current application.
- Date Book, To Do List, Memo Pad: Phone Lookup displays the Address list screen and lets you add the information that appears in this list to a record.
- Address Book: The Look Up line lets you enter the first letters of a name to scroll immediately to that name.
- Expense: Lookup displays the names in your Address Book that have data in the Company field. You can add these names to a list of attendees associated with an Expense record.



## Looking up Address Book records

When working with Address Book, the scroll button on the front panel of the organizer makes it easy to navigate among your address entries.

- In the Address list screen, the scroll button moves up or down an entire screen of records. If you hold down the scroll button, you accelerate the scrolling and display every third screen.
- In the Address view screen, the scroll button moves to the previous or next address record.

You can also use the Address list Look Up feature to quickly scroll to any of your Address Book entries.

**To look up an Address Book record:**

1. Display the Address list screen.
2. Enter the first letter of the name you want to find.

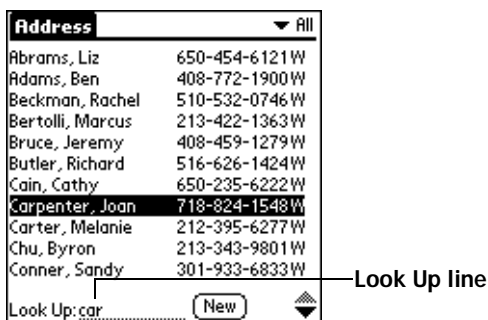

The list scrolls to the first entry that begins with that letter. If you write another letter, the list scrolls to the first entry that starts with those *two* letters. For example, writing an “s” scrolls to “Sands,” and writing “sm” scrolls further to “Smith.” If you sort the list by company name, the Look Up feature scrolls to the first letter of the company name.

3. Tap the record to view its contents.

## Using Find

You can use Find to locate any text that you specify, in any application.

### To use Find:

1. Tap the Find icon .

**Tip:** If you select text in an application before you tap Find, the selected text automatically appears in the Find dialog box.

2. Enter the text that you want to find.

Find is *not* case-sensitive. For example, searching for the name “davidson” also finds “Davidson.”

Find locates any words that begin with the text you enter. For example, searching for “plane” finds “planet,” but not “airplane.”

3. Tap OK.

Find searches for the text in all records and all notes.

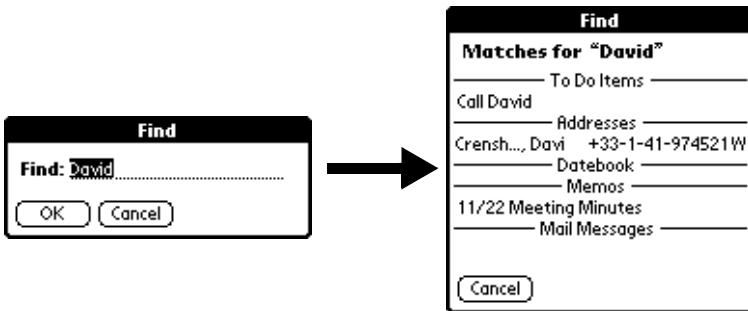

As your organizer searches for the text, you can tap Stop at any time. You may want to do this if the entry you want appears before your organizer finishes the search. To continue the search after you tap Stop, tap Find More.

4. Tap the text that you want to review.

## Using Phone Lookup

Phone Lookup displays the Address list screen and lets you add the information that appears in this list to a record.

### To use Phone Lookup:

1. Display the record in which you want to insert a phone number. The record can be in Date Book, To Do List, or Memo Pad.
2. Tap the Menu icon .
3. Tap Options, and then tap Phone Lookup.
4. Begin to spell the last name of the name you want to find.

The list scrolls to the first record in the list that starts with the first letter you enter. Continue to spell the name you're looking for, or when you see the name, tap it.



5. Tap Add.

The name you selected, along with the other information associated with it, is pasted into the record you selected in step 1.

### Phone Lookup tips

Write the Graffiti Command stroke “/L” to activate the Phone Lookup feature. You can also activate it in the following circumstances:

- While entering text: For example, to insert the full name and phone number for someone with the last name “Williams,” write the Graffiti characters for “Wi” and then the Phone Lookup Command stroke “/L.”

Assuming you have only one Address Book record that begins with “Wi,” your organizer inserts the full name “Fred Williams” (and its associated information). If you have more than one name that begins with “Wi,” the Phone Lookup screen appears and highlights the first record that begins with “Wi.”

- For selected text: Drag to highlight the text, and then write the Phone Lookup Command stroke “/L.” Your organizer replaces the selected text and adds the name and its associated information.

## Looking up names to add to expense records

In Expense, Lookup displays the names in your Address Book that have data in the Company field. You can add these names to a list of attendees associated with an Expense record.

To add names to an Expense record:

1. Tap the Expense record to which you want to add names.
2. Tap Details.

**Receipt Details**

Category: ▼ Unfiled  
Type: ▼ Lunch  
Payment: ▼ Unfiled  
Currency: ▼ \$  
Vendor: .....  
City: .....  
Attendees: Who...  
OK Cancel Delete Note ↑

3. Tap Who.

**Receipt Details**

Category: ▼ Unfiled  
Type: ▼ Lunch  
Payment: ▼ MasterCard  
Currency: ▼ \$  
Vendor: Rosie's Cafe  
City: San Francisco  
Attendees: Who... Tap here  
OK Cancel Delete Note ↑

**Attendees**

Done Lookup R A ↑

4. Tap Lookup.

The Attendees Lookup screen displays all the names in your Address Book that have data in the Company field.

5. Select the name you want to add, and then tap Add.

The name appears in the Attendees screen.

6. Repeat steps 4 and 5 to add more names.
7. Tap Done.
8. Tap OK.

## Sorting lists of records

You can sort lists of records in various ways, depending on the application. Sorting is available in applications that have list screens: Address Book, To Do List, Memo Pad, and Expense.

**Note:** You can also assign records to categories. See “Categorizing records” earlier in this chapter.

**To sort records in To Do List and Expense:**

1. Open the application to display the list screen.
2. Tap Show.
3. Tap the Sort by pick list and select an option.
4. Tap OK.

**To sort records in Address Book and Memo Pad:**

1. Open the application to display the list screen.
2. Tap the Menu icon .
3. Tap Options, and then tap Preferences.

Address Book:

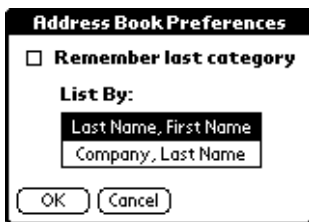

Memo Pad:

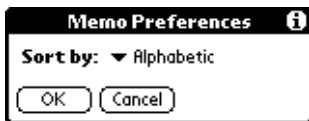

4. Do one of the following:

Address Book: Tap the setting you want.

Memo Pad: Tap the Sort by pick list and select Alphabetic or Manual.

5. Tap OK.

To sort the Memo list manually, tap and drag a memo to a new location in the list.

**Note:** To make the list of your memos appear in Palm Desktop software as you manually sorted it on your organizer, open Memo Pad in Palm Desktop software and click List by. Then select Order on handheld.

## Making records private

In all basic applications except Expense and Mail, you can make individual records private. Private records remain visible and accessible, however, until you select the Security setting to hide or mask all private records. See “Security” in Chapter 3 for more information.

## Hiding or masking private records

You can hide or mask all records that you mark as private. Masked records appear as grey placeholders in the same position they would appear if they were not masked, and are marked with a lock icon. Hidden records disappear completely from the screen. If you define a password for your organizer, you must enter it to display private records.

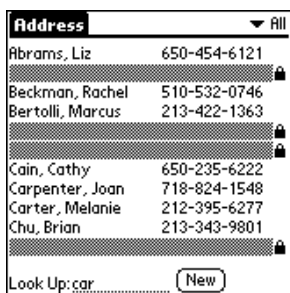

To hide all private records:

1. Tap the Applications icon .
2. Tap Security.
3. Tap the Current Privacy pick list and select Hide Records.

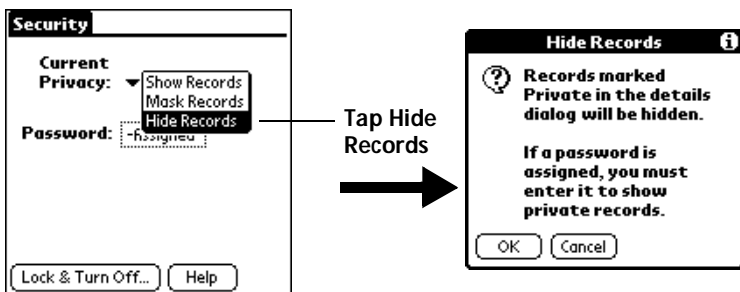

4. Tap OK to confirm that you want to hide private records.

To mask all private records:

1. Tap the Applications icon .
2. Tap Security.
3. Tap the Current Privacy pick list and select Mask Records.

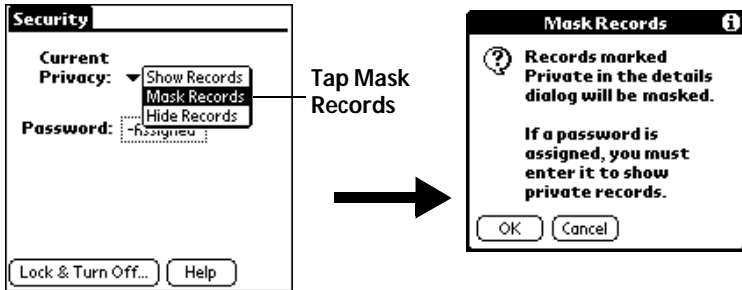

4. Tap OK to confirm that you want to mask private records.

To display private records:

1. Do one of the following:

Tap a masked record.

Tap the Applications icon , tap Security, then tap the Current Privacy pick list and select Show Records.

If you do not have a password, hidden and masked records become visible.

If you have a password, the Show Private Records dialog box appears. Go to step 2.

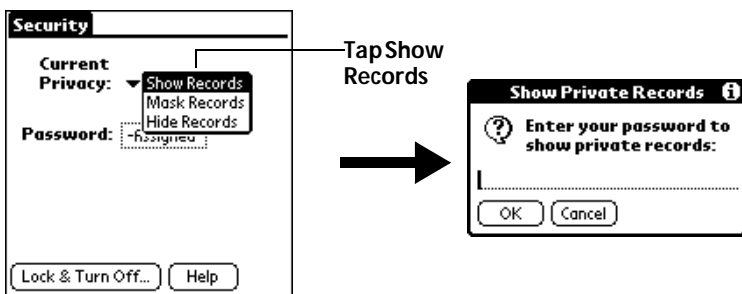

2. Enter your password, and then tap OK.

To make a record private:

1. Display the entry that you want to make private.
2. Tap Details.

3. Tap the Private check box to select it.
4. Tap OK.

## Attaching notes

In all basic applications except Memo Pad, you can attach a note to a record. A note can be up to several thousand characters long. For example, for an appointment in Date Book, you can attach a note with directions to the location.

### To attach a note to a record:

1. Display the entry to which you want to add a note.
2. In Address Book only: Tap Edit.
3. Tap Details.
4. Tap Note.
5. Enter your note.
6. Tap Done.

A small note icon appears at the right side of any item that has a note.

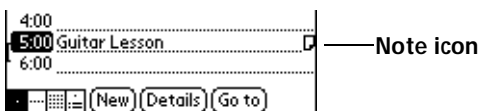

### To review or edit a note:

1. Tap the Note icon .

### To delete a note:

1. Tap the Note icon .
2. Tap Delete.
3. Tap Yes.



## Choosing fonts

In all basic applications except Expense, you can change the font style to make text easier to read. You can choose a different font style for each application.

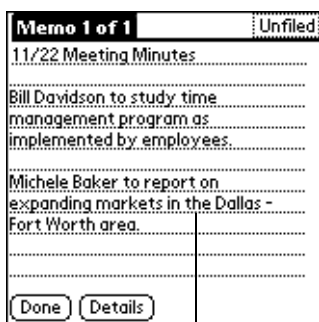

Small font



Large font

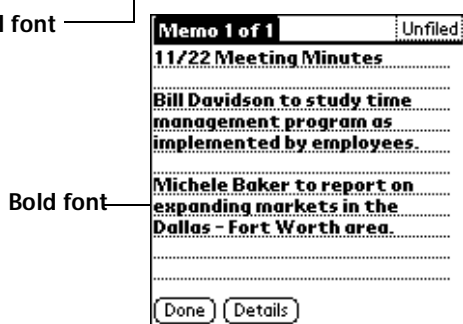

Bold font

To change the font style:

1. Open an application.
2. Tap the Menu icon .
3. Tap Options, and then tap Font.
4. Tap the font style you want to use.

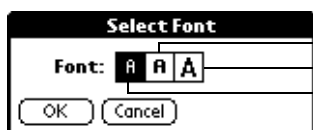

Tap here for bold font

Tap here for large font

Tap here for small font

5. Tap OK.

# Application-specific tasks

## Date Book

When you open Date Book, the screen shows the current date and a list of times for a normal business day.

### Scheduling an event

A record in Date Book is called an “event.” An event can be any kind of activity that you associate with a day. You can enter a new event on any of the available time lines.

When you schedule an event, its description appears on the time line, and its duration is automatically set to one hour. You can easily change the start time and duration for any event.

**Note:** It’s possible to schedule events that overlap, but Date Book makes it easy to find such conflicts. See “Spotting event conflicts” later in this chapter.

You can also schedule events in your Date Book that occur on a particular date but have no specific start or end times, such as birthdays, holidays, and anniversaries. These are referred to as “untimed events.” Untimed events appear at the top of the list of times, marked with a diamond. You can have more than one untimed event on a particular date.

You can also schedule a repeating event, such as a weekly meeting, and continuous events, such as a three-day conference or a vacation.

To schedule an event for the current day:

1. Tap the time line that corresponds to the beginning of the event.

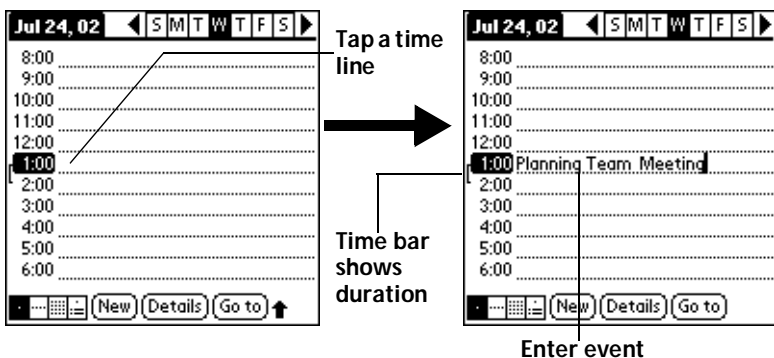

2. Enter a description of the event. You can enter up to 255 characters.

- If the event is one hour long, skip to step 5. If the event is longer or shorter than an hour, tap the time of the event to open the Set Time dialog box.

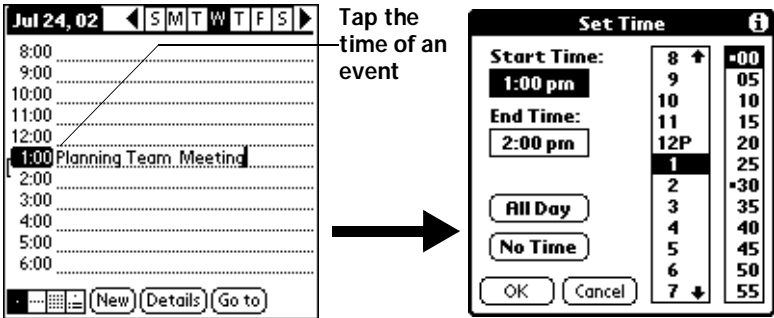

**Tip:** You can also open the Set Time dialog (to select a start time) by making sure no event is selected, and then writing a number on the number side of the Graffiti writing area.

- Do one of the following:

Tap the time columns on the right side of the Set Time dialog to set the Start Time, then tap the End Time box and tap the time columns to set the End Time.

Tap All Day to automatically insert the start and end time of the event as defined in your Date Book preferences.

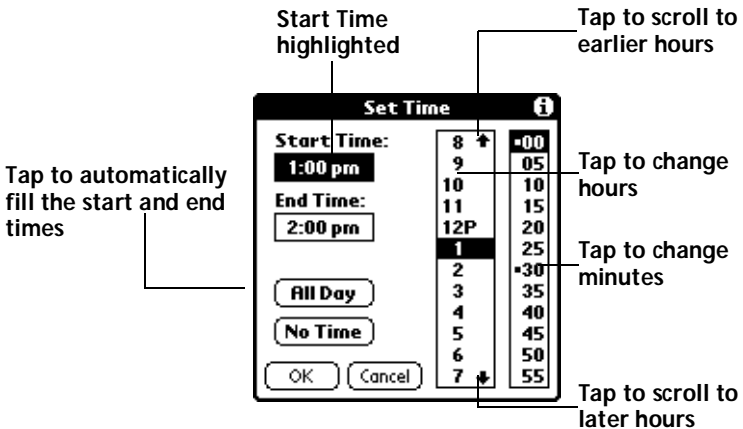

- Tap OK.

6. Tap a blank area of the screen to deselect the event. A vertical line appears next to the time, indicating the duration of the event.

**Note:** If an event has the same start and end time, the time is only displayed once.

**To schedule an event for another day:**

1. Select the date you want for the event by doing one of the following:
  - Tap the day of the week that you want in the date bar at the top of the screen. If necessary, tap the Previous week or Next week scroll arrows to move to another week.

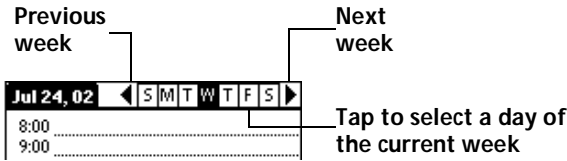

**Tip:** You can also use the scroll button on the front panel of your organizer to move forward or backward one day at a time.

- Tap Go To at the bottom of the screen to open the Go to Date dialog box. Select a date by tapping a year, month, and day in the calendar.

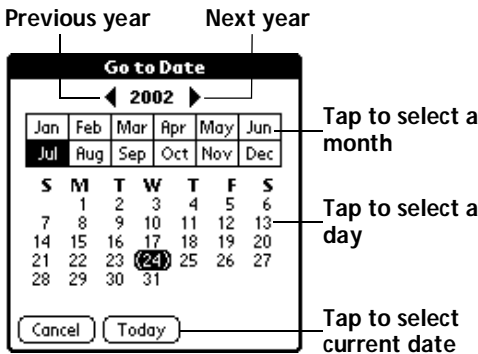

**Tip:** In the Go to Date dialog box, you can also use the scroll button on the front panel of the organizer to move forward or backward one month at a time.

2. After you locate the date, follow the steps for scheduling an event for the current day.

**To schedule an untimed event:**

1. Select the date that you want for the event as described in “To schedule an event for another day.”
2. Tap New.
3. Tap No Time, so that no start or end times are defined for the new event.

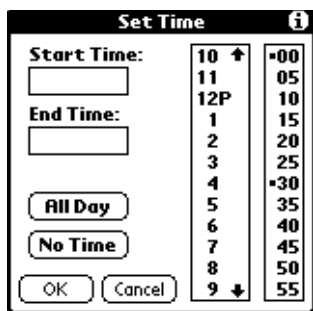

**Tip:** You can also create a new untimed event by making sure no event is selected and then writing letters in the Graffiti writing area.

4. Enter a description of the event.

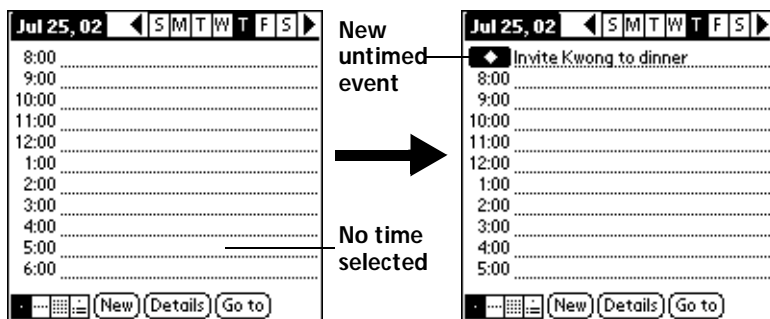

5. Tap a blank area on the screen to deselect the untimed event.

**Note:** If you create an event and decide later that there is no particular start or end time, you can easily change it to an untimed event. Tap the time of the event in the Date Book screen, tap No Time, and then tap OK.

## Rescheduling an event

You can easily make changes to your schedule with your organizer.

### To reschedule an event:

1. Tap the event you want to reschedule.
2. Tap Details.
3. To change the time, tap the Time box and select a new time.
4. To change the date, tap the Date box and select a new date.
5. Tap OK.

## Setting an alarm for an event

The Alarm setting enables you to set an audible alarm for events in your Date Book. You can set an alarm to sound minutes, hours, or days before an event. The default Alarm setting is 5 minutes before the time of the event, but you can change this to any number of minutes, hours, or days.

When you set an alarm, this icon  appears to the far right of the event with the alarm. When the alarm tone sounds, a reminder message also appears onscreen.

### To set an alarm for an event:

1. Tap the event to which you want to assign an alarm.
2. Tap Details.
3. Tap the Alarm check box to select it.

The default setting, 5 Minutes, appears.

4. Tap the pick list to select Minutes, Hours, or Days.
5. Select the 5 and enter any number from 0 to 99 (inclusive) as the number of time units.

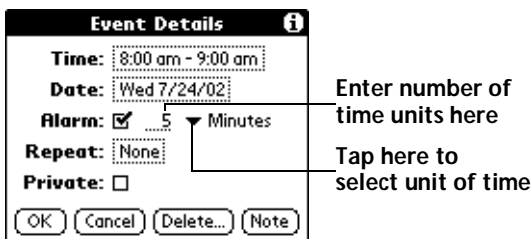

6. Tap OK.

7. When the reminder message appears on screen, do one of the following:

Tap OK to permanently dismiss the reminder and return to the current screen.

Tap Snooze to dismiss the reminder and return to the current screen. The reminder message appears again five minutes after you tap Snooze.



**Alarm for untimed events:** You can set a silent alarm for an untimed event. In this case, the alarm triggers at the specified period of minutes, hours, or days before midnight (beginning) of the day of the untimed event. No audible alarm sounds for an untimed event; instead, the reminder message appears onscreen.

For example, you set an alarm for an untimed event that occurs on February 4th. If the alarm is set for 5 minutes, the reminder message appears at 11:55 PM on the night of February 3rd. The reminder remains onscreen until you turn on your organizer and tap OK to dismiss it.

### **Scheduling repeating or continuous events**

The Repeat function lets you schedule events that recur at regular intervals or extend over a period of consecutive days.

A birthday is a good example of an event that repeats annually. Another example is a weekly guitar lesson that falls on the same day of the week and the same time of day.

A business trip or a vacation is an example of a continuous event.

To schedule a repeating or continuous event:

1. Tap the event.

Typically, a continuous event is an untimed event.

2. Tap Details.
3. Tap the Repeat box to open the Change Repeat dialog box.

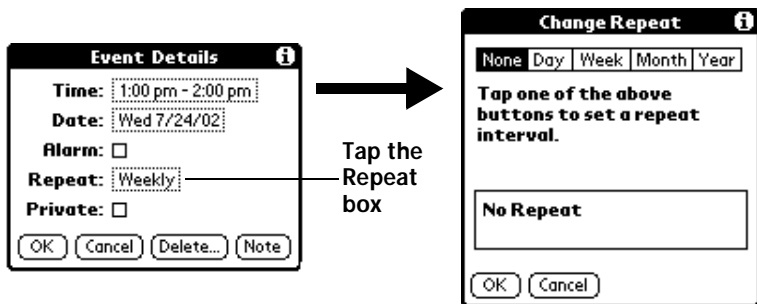

4. Tap Day, Week, Month, or Year to set how often event repeats.  
For a continuous event, tap Day.
5. Enter a number that corresponds to how often you want the event to repeat on the Every line.

For example, if you select Month and enter the number 2, the event repeats every other month.

6. To specify an end date for the repeating or continuous event, tap the End on pick list and tap Choose Date. Use the date picker to select an end date.
7. Tap OK.

After you schedule a repeating or continuous event, this icon  appears to the far right of the event.

## Changing repeating or continuous events

When you make changes to a repeating or continuous event, such as deleting or adding notes, or changing the time of an event, you can decide which of the events you want to change; all events in the series, just the current event, or the current and future events.

To delete repeating events:

1. Select the record you want to delete.
2. Tap the Menu icon .



3. Tap Record, and then tap Delete Event.
4. Do one of the following:

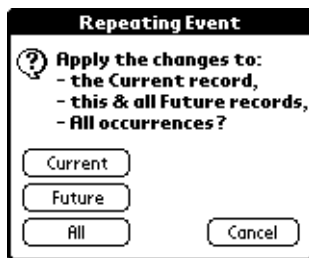

Tap Current to delete only the current event item.

Tap Future to delete the current and all future event items and reset the end date of the repeating event to the last shown date.

Tap All to delete all occurrences of the repeating event.

5. Tap OK.

Considerations for repeating or continuous events: Keep the following points in mind.

- If you change the start date of a repeating event, your organizer calculates the number of days you moved the event. Your organizer then automatically changes the end date to maintain the duration of the repeating event.
- If you change the repeat interval (e.g., daily to weekly) of a repeating event, past occurrences (prior to the day on which you change the setting) are not changed, and your organizer creates a new repeating event.
- If you change the date of an occurrence of a repeating event (e.g., from January 14th to January 15th) and apply the change to all occurrences, the new date becomes the start date of the repeating event. Your organizer adjusts the end date to maintain the duration of the event. If you apply the change to current and future occurrences, past occurrences are not changed.
- If you change other repeat settings (e.g., time, alarm, private) of a repeating event and apply the change to all occurrences, your organizer creates a new event. The start date of this new event is the day on which the setting is changed. Past occurrences (prior to the day of the change) are not changed.
- If you apply a change to a single occurrence of a repeating event (e.g., time), that occurrence no longer shows the Repeat icon .

## Changing the Date Book view

In addition to displaying the time list for a specific day, you can also display a whole week, a month, or an agenda. You can also display the current time.

To cycle through Day, Week, Month, and Agenda views:

- Press the Date Book application button repeatedly to display the next view.
- Tap on the appropriate view icon in the lower-left corner of Date Book.

## Working in Week View

Week View shows the calendar of your events for an entire week. This view lets you quickly review your appointments and available time slots. In addition, the graphical display helps you spot overlaps and conflicts in your schedule.

To display the Week View:

1. Tap the Week View button.



2. Tap the navigation controls to move forward or backward a week at a time, or tap on a column to display details of an event.

**Note:** The Week View also shows untimed events and events that are before and after the range of times shown.

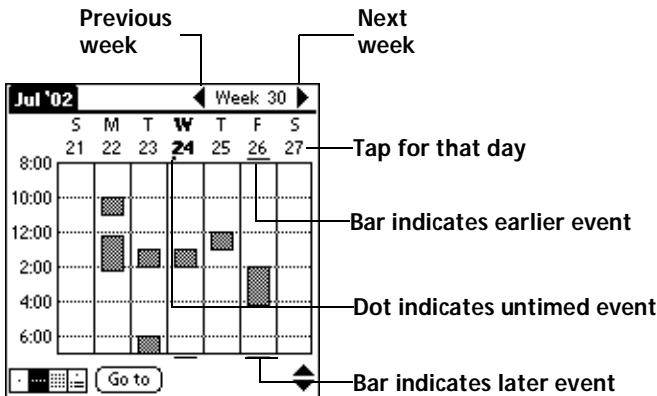

3. Tap an event to show a description of the event.

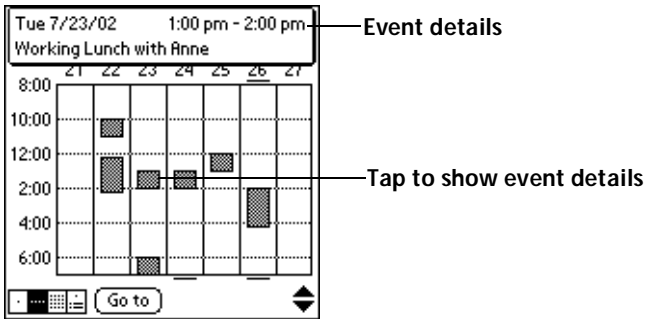

Tips for using Week View: Keep the following points in mind.

- To reschedule an event, tap and drag the event to a different time or day.
- Tap a blank time on any day to move to that day and have the time selected for a new event.
- Tap any day or date that appears at the top of the Week View to move directly to that day without selecting an event.
- The Week View shows the time span defined by the Start Time and End Time in the Date Book Preferences settings. If you have an event before or after this time span, a bar appears at the top or bottom of that day's column. Use the onscreen scroll arrows  to scroll to the event.

## Spotting event conflicts

With the ability to define specific start and end times for any event, it's possible to schedule events that overlap (an event that starts before a previous event finishes).

An event conflict (time overlap) appears in the Week View as overlapping bars. The Day View displays overlapping brackets to the left of the conflicting times.

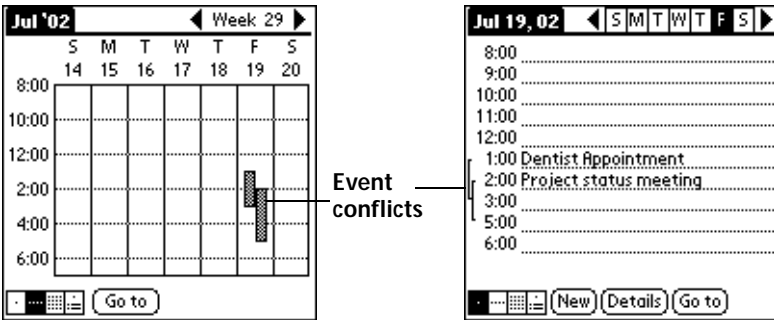

## Working in Month View

The Month View screen shows which days have events scheduled. Dots and lines in the Month View indicate events, repeating events, and untimed events.

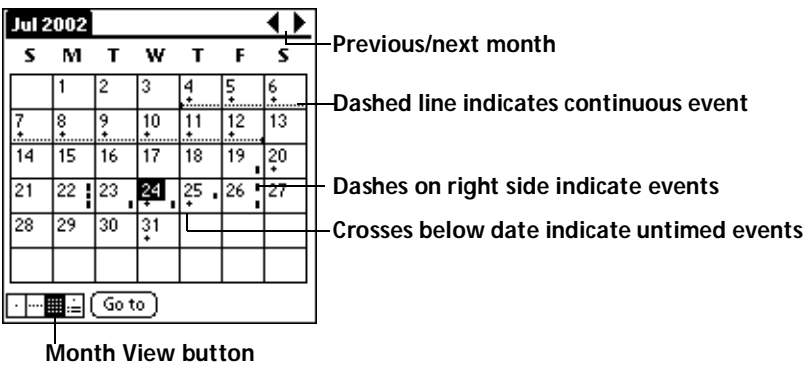

You can control the dots and lines that appear in the Month View. See “Options menu” later in this chapter.

Tips for using Month View: Keep the following points in mind.

- Tap a day in the Month View to display that day in the Day View.
- Tap the scroll arrows in the upper-right corner to move forward or backward a month.

- Tap Go to to open the date selector and select a different month.
- Use the scroll button on the front panel of your organizer to move between months. Press the upper half of the button to display the previous month, the lower half to display the next month.

## Working in Agenda View

The Agenda view shows you your untimed events, appointments, and To Do items in one screen. When you tap on an untimed event or appointment in the Agenda view, the Day view appears so you can see more detailed information about the event. You can tap the check box next to a To Do item to mark it as completed. When you tap on a To Do item, your To Do list appears.

**Note:** The To Do items that appear and how you can change them depends on the settings in your To Do preferences. See “To Do Show Options” later in this chapter for more information.

### To display the Agenda View:

1. Tap the Agenda View button.



2. Tap the navigation controls to move forward or backward a day at a time, or to display more events and To Do items.

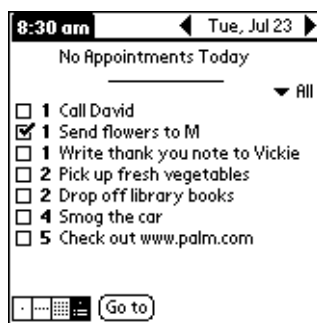
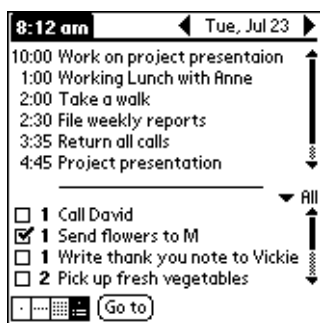

**Note:** You can also change the category of To Do items shown. Click on the pick list to choose another category. See “To Do List” for more information on working with To Do items.

## Date Book menus, preferences, and display options

Date Book menus are shown here for your reference, and Date Book features that are not explained elsewhere in this book are described here.

See “Using menus” in Chapter 1 for information about choosing menu commands.

### Record menu



### Options menu

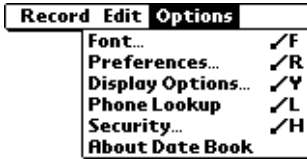

**Display Options** Allows you to change Date Book’s appearance and which events display.



- **Show Time Bars.** Activates the time bars that appear in the Day View. The time bars show the duration of an event and illustrate event conflicts.

- **Compress Day View.** Controls how times appear in the Day View. When Compress Day View is off, all time slots display. When it is on, start and end times display for each event, but blank time slots toward the bottom of the screen disappear to minimize scrolling.
- **Month View settings.** These check boxes apply to the Month View of the Date Book. You can activate any or all of these settings to show that you have Timed, Untimed, or Daily Repeating events in the Month View *only*.

## Preferences



- **Start/End Time.** Defines the start and end times for Date Book screens. If the time slots you select do not fit on one screen, you can tap the scroll arrows  to scroll up and down.
- **Alarm Preset.** Automatically sets an alarm for each new event. The silent alarm for untimed events is defined by minutes, days, or hours before midnight of the date of the event.
- **Alarm Sound.** Sets the tone of the alarm.
- **Remind Me.** Defines how many times the alarm sounds. The choices are Once, Twice, 3 Times, 5 Times, and 10 Times.
- **Play Every.** Defines how often the alarm sounds. The choices are Minute, 5 minutes, 10 minutes, and 30 minutes.

## About Date Book

Shows version information for Date Book.

# Address Book

Address Book is the application in which you store name and address information about people or businesses.

## Creating an Address Book entry

A record in Address Book is called an “entry.” You can create entries on your organizer, or you can use Palm Desktop software to create entries on your computer and then download the entries to your organizer with your next HotSync operation.

Palm Desktop software also has data import capabilities that enable you to load database files into Address Book on your organizer.

See “Importing data” in Chapter 2 and Palm Desktop online Help for more information.

To create a new Address Book entry:

1. Press the Address Book application button  on the front of your organizer to display the Address list.
2. Tap New.

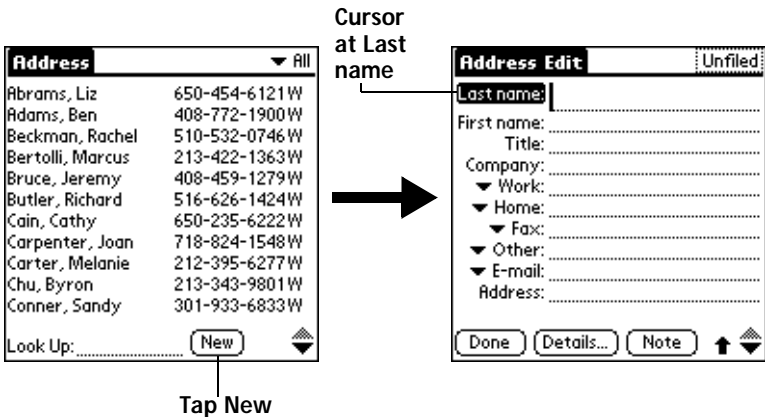

3. Enter the last name of the person you want to add to your Address Book.

**Note:** The organizer automatically capitalizes the first letter of each field (except numeric and e-mail fields). You do not have to use the Graffiti capital stroke to capitalize the first letter of the name.



4. Use the Next Field Graffiti stroke to move to the First Name field.



**Tip:** You can also move to any field by tapping it directly.

5. Enter the person's first name in the First Name field.
6. Enter the other information that you want to include in this entry.

**Note:** As you enter letters in the Title, Company, City, and State fields, text appears for the first logical match that exists in your Address Book. As you enter more letters, a closer match appears. For example, you may already have Sacramento and San Francisco in your Address Book. As you enter "S" Sacramento appears, and as you continue entering "a" and "n" San Francisco replaces Sacramento. As soon as the word you want appears, tap in the next field to accept the word.

7. Tap the scroll arrows  $\blacktriangle$  to move to the next page of information.
8. After you finish entering information, tap Done.



Tap Done

**Tip:** To create an entry that always appears at the top of the Address list, begin the Last name or Company field with a symbol, as in \*If Found Call\*. This entry can contain contact information in case you lose your organizer.

### Selecting types of phone numbers

You can select the types of phone numbers or e-mail addresses that you associate with an Address Book entry. Any changes you make apply only to the current entry.

To select other types of phone numbers in an entry:

1. Tap the entry that you want to change.
2. Tap Edit.
3. Tap the pick list next to the label you want to change.

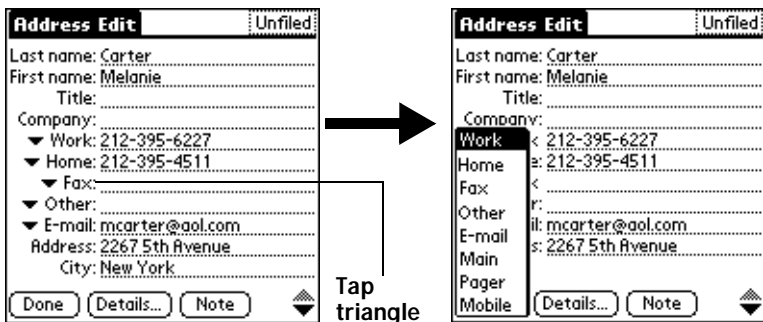

4. Select a new label.

### Changing Address Entry details

The Address Entry Details dialog box provides a variety of options that you can associate with an entry.

To open the Address Entry Details dialog box:

1. Tap the entry whose details you want to change.
2. Tap Edit.
3. Tap Details.



4. Select any of the following settings:

**Show in List** Select which type of phone or other information appears in the Address list screen. Your options are Work, Home, Fax, Other, E-mail, Main, Pager, and Mobile. The identifying letters W, H, F, O, E, M, or P appear next to the record in the Address list, depending on which information is displayed. If the E-mail or Other fields end in a letter, the identifying letters are not displayed.

**Category** Assign the entry to a category.

**Private** Hide this entry when Security is turned on.

### Address Book menus

Address Book menus are shown here for your reference, and Address Book features that are not explained elsewhere in this book are described here.

See “Using menus” in Chapter 1 for information about choosing menu commands.

The Record and Options menus differ depending on whether you’re displaying the Address list screen or the Address view screen.

### Record menus



Address list



Address view

**Duplicate Address** Makes a copy of the current record and displays the copy in Address Edit so you can make changes to the copied record. The copy has the same category and attached notes as the original record.

## Options menus



Address list



Address view

## Preferences

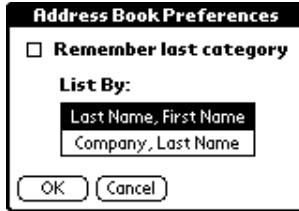

- Remember last category. Determines how Address Book appears when you return to it from another application. If you select this check box, Address Book shows the last category you selected. If you clear it, Address Book displays the All category.

## Rename Custom Fields

These custom fields appear at the end of the Address Edit screen. Rename them to identify the kind of information you enter in them. The names you give the custom fields appear in all entries.



## About Address Book

Shows version information for Address Book.

## To Do List

A To Do List item is a reminder of some task that you have to complete. A record in To Do List is called an “item.”

To create a To Do List item:

1. Press the To Do List application button  on the front of your organizer to display the To Do List.
2. Tap New.

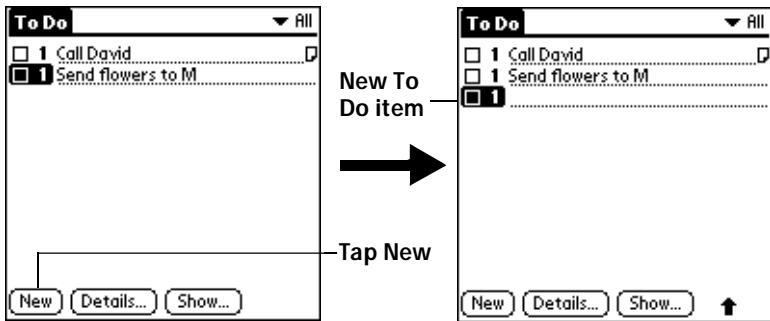

3. Enter the text of the To Do List item. The text can be longer than one line.
4. Tap anywhere onscreen to deselect the To Do List item.

**Tip:** If no To Do List item is currently selected, writing in the Graffiti writing area automatically creates a new item.

### Setting priority

The priority setting for items lets you arrange the tasks in your To Do List according to their importance or urgency. The default setting for the To Do List is to arrange items by priority and due date, with priority 1 items at the top. If you have a number of items in your list, changing an item’s priority setting may move its position in the list.

**Note:** When you create a new To Do List item, its priority is automatically set to level 1, the highest (most important) level. If you select another item first, however, the item you create appears beneath the selected item and is given the same priority as the selected item.

To set the priority of a To Do List item:

1. Tap the Priority number on the left side of the To Do List item.

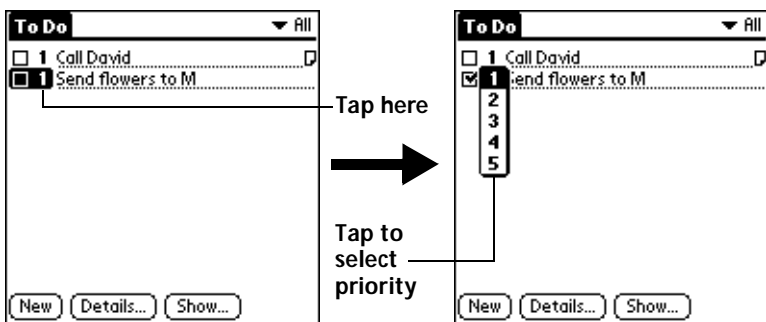

2. Tap the Priority number that you want to set (1 is most important).

### Checking off a To Do List item

You can check off a To Do List item to indicate that you've completed it. You can set the To Do List to record the date that you complete the To Do item, and you can choose to show or hide completed items. See "To Do Show Options" later in this chapter.

To check off a To Do List item:

- Tap the check box on the left side of the item.

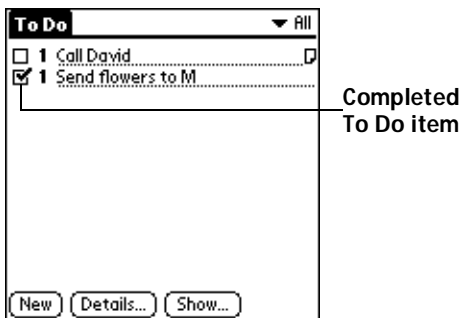

### Changing To Do List item details

The To Do Item Details dialog box enables you to change settings for individual items.

To display the To Do Item Details dialog box:

1. Tap the text of the item whose details you want to change.
2. Tap Details.



### Setting a due date

You can associate a due date with any To Do List item. You can also sort the items that appear in the list based on their due date.

To set a due date for a To Do List item:

1. In the Details dialog box, tap “No Date” to open the Due Date pick list.

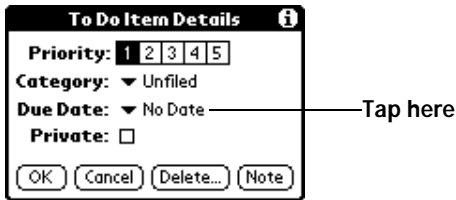

2. Tap the date that you want to assign the item:

<b>Today</b>	Assigns the current date.
<b>Tomorrow</b>	Assigns tomorrow’s date.
<b>One week later</b>	Assigns the date exactly one week from the current date.
<b>No Date</b>	Removes the due date from the item.
<b>Choose date</b>	Opens the date selector, where you can choose any date that you want for the item.

3. Tap OK.

**Tip:** If you turn on the Show Due Dates option in the To Do Show options dialog, you can tap directly on the due date in the To Do List to open the pick list shown in step 2.

## To Do Show Options

The Show Options dialog box enables you to control the appearance of To Do List, and To Do items in Date Book Agenda view.

To change the Show Options settings:

1. In To Do List, tap Show.



2. Select any of the following settings:

### Show Completed Items

Displays your completed items in the To Do List. If you turn off this setting, your To Do items disappear from the list when you complete (check) them.

Items that no longer appear on the list because you turn off this setting have not been deleted. They are still in the memory of your organizer. Purge completed items to remove them from memory.

### Show Only Due Items

Shows only the items that are currently due, past due, or have no due date specified. When this setting is active, items that are not yet due do not appear in the list until their due date.

### Record Completion Date

Replaces the due date with the actual date when you complete (check) the item. If you do not assign a due date to an item, the completion date still records when you complete the item.



**Show Due Dates** Displays the due dates associated with items in the To Do List and displays an exclamation mark next to items that remain incomplete after the due date passes.

**Show Priorities** Shows the priority setting for each item.

**Show Categories** Shows the category for each item.

3. Tap OK.

### To Do List menus

To Do List menus are shown here for your reference, and To Do List features that are not explained elsewhere in this book are described here.

See “Using menus” in Chapter 1 for information about choosing menu commands.

### Record menu

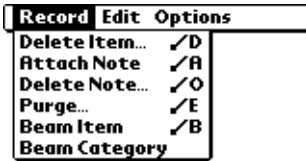

### Options menu



**About To Do List** Shows version information for To Do List.

## Memo Pad

A memo can contain up to 4,000 characters. The number of memos you can store is dependent only on the memory available on your organizer. A record in Memo Pad is called a “memo.”

To create a new memo:

1. Press the Memo Pad application button  on the front of your organizer to display the Memo list.
2. Tap New.

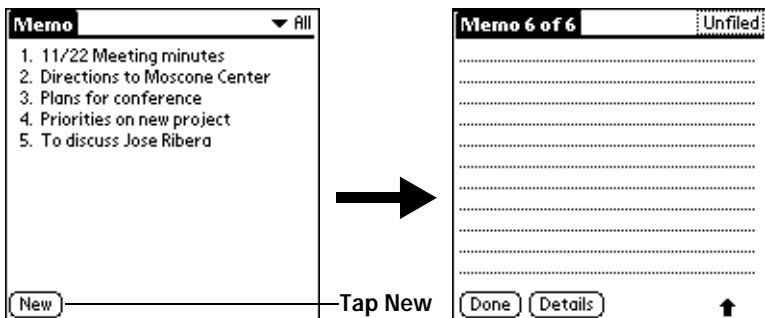

**Tip:** In the Memo list screen, you can also begin writing in the Graffiti writing area to create a new memo. The first letter is automatically capitalized and begins your new memo.

3. Enter the text you want to appear in the memo. Use the carriage return stroke to move down to new lines in the memo.
4. Tap Done.

### Reviewing memos

The first line of a memo appears in the Memo list. This makes it easy to locate and review your memos.

To review a memo:

1. In the Memo list, tap the text of the memo.



Tap a memo to review its contents

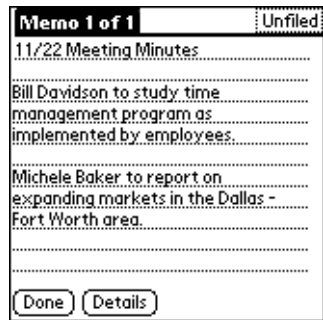

2. Review or edit the text in the memo.
3. Tap Done.

## Memo Pad menus

Memo Pad menus are shown here for your reference, and Memo Pad features that are not explained elsewhere in this book are described here.

See “Using menus” in Chapter 1 for information about choosing menu commands.

The Record and Options menus differ depending on whether you’re displaying the Memo list or an individual memo.

## Record menus

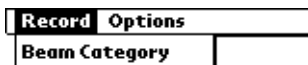

Memo list

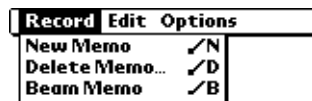

Memo screen

## Options menus



Memo list



Memo screen

<b>Go to Top of Page</b>	Moves to the top (first) line of the memo.
<b>Go to Bottom of Page</b>	Moves to the bottom (last) line of the memo.
<b>Preferences</b>	Displays the Memo Preferences dialog box, where you define the sort order for memos.
<b>About Memo Pad</b>	Shows version information for Memo Pad.

## Calculator

The Calculator includes several buttons to help you perform calculations.



Clears the last number you entered. Use this button if you make a mistake while entering a number in the middle of a calculation. This button enables you to re-enter the number without starting the calculation over.



Clears the entire calculation and enables you to begin a fresh calculation.



Toggles the current number between a negative and positive value. If you want to enter a negative number, enter the number first *and then press* the +/- button.



Places the current number in memory. Each new number you enter with the M+ button is *added to the total* already stored in memory. The number that you add can be either a calculated value or any number you enter by pressing the number buttons. Pressing this button has no effect on the current calculation (or series of calculations); it merely places the value into memory until it is recalled.



Recalls the stored value from memory and inserts it in the current calculation.



Clears any value that is stored in the Calculator memory.

## Recent Calculations

The Recent Calculations command enables you to review the last series of calculations and is particularly useful for confirming a series of “chain” calculations.

To display recent calculations:

1. Tap the Menu icon .
2. Tap Options, and then tap Recent Calculations.

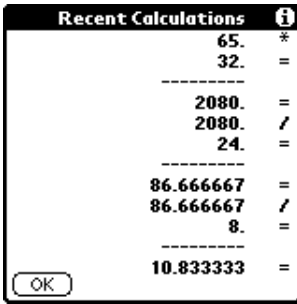

3. After you finish reviewing the calculations, tap OK.

### Calculator menus

Calculator menus are shown here for your reference, and Calculator features that are not explained elsewhere in this book are described here.

See “Using menus” in Chapter 1 for information about choosing menu commands.

### Options menus

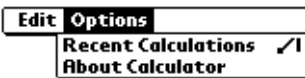

**About Calculator** Shows version information for Calculator.

## Expense

Expense enables you to record the date, expense type, and the amount that you spent. A record in Expense is called an “item.” You can sort your Expense items into categories or add other information that you want to associate with the item.

To create an Expense item:

1. Tap the Applications icon .
2. Tap Expense.
3. Tap New.

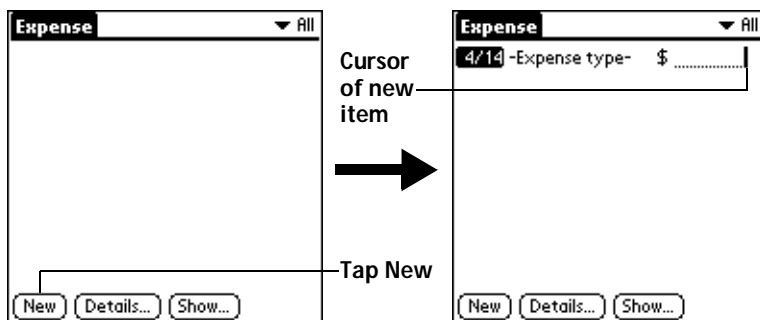

**Tip:** You can also create a new Expense item by writing on the number side of the Graffiti writing area while in the Expense list screen. The first number you write begins the amount of your new Expense item.

4. Enter the amount of the expense.
5. Tap the Expense type pick list and select a type from the list.

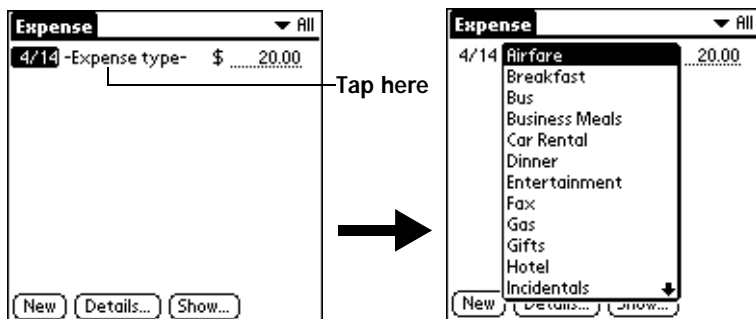

**Note:** As soon as you select an expense type, your organizer saves your entry. If you do not select an expense type, it does not save the entry.

**Tip:** Another quick way to create a new Expense item is to make sure that no Expense item is selected in the Expense list, write the first letter(s) of the expense type, and then write the numerical amount of the Expense item. This technique takes advantage of the automatic fill feature. See “Options menu” later in this chapter for details.

### Changing the date of an Expense item

Initially, Expense items appear with the date you enter them. You can use Expense to change the date associated with any Expense item.

To change the date of an Expense item:

1. Tap the Expense item you want to change.
2. Tap the date of the selected item.

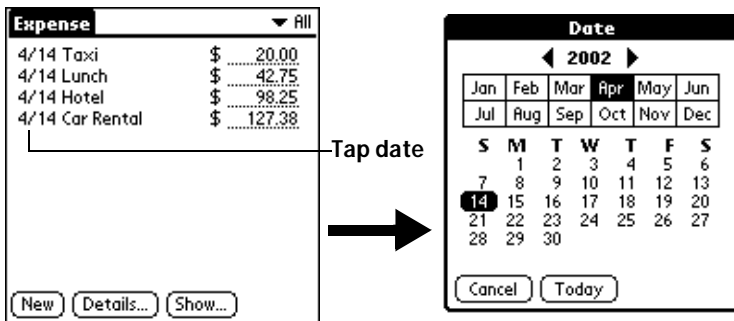

3. Tap the new date.

### Entering receipt details

Expense provides a variety of options that you can associate with an item. These options appear in the Receipt Details dialog box.

To open the Receipt Details dialog box:

1. Tap the Expense item to which you want to assign details.
2. Tap Details.





3. Select any of the following options:

<b>Category</b>	See “Categorizing records” earlier in this chapter.
<b>Type</b>	Opens a pick list of expense types.
<b>Payment</b>	Lets you choose the payment method used to pay the Expense item. If the item is prepaid (such as airline tickets supplied by your company), you can choose Prepaid to place your expense in the appropriate company-paid cell of your printed expense report spreadsheet. See “Transferring your data to Microsoft Excel” later in this chapter for more information.
<b>Currency</b>	Enables you to choose the type of currency used to pay the Expense item. The default currency unit is defined in the Preferences dialog box. You can also display up to four other common types of currency. See “Customizing the Currency pick list” later in this chapter for more information.
<b>Vendor and City</b>	Lets you record the name of the vendor (usually a company) associated with the expense and the city where the expense was incurred. For example, a business lunch might be at Rosie's Cafe (Vendor) in San Francisco (City).
<b>Attendees</b>	See “Looking up names to add to expense records” earlier in this chapter.

4. Tap OK.

## Customizing the Currency pick list

You can select the currencies and symbols that appear in the Currency pick list.

To customize the Currency pick list:

1. Tap the Currency pick list in the Receipt Details dialog box, and then select Edit currencies.

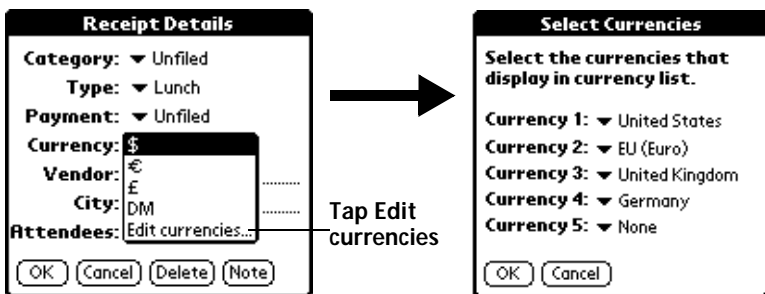

2. Tap each Currency pick list and select the country whose currency you want to display on that line.
3. Tap OK to close the Select Currencies dialog box.
4. Tap OK.

To change your default currency:

1. Open Expense.
2. Tap the Menu icon .
3. Tap Options, and then tap Preferences.
4. Tap the Default Currency pick list.
5. Tap the currency symbol you want to appear in Expense.

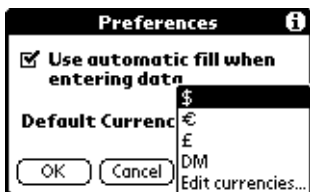

6. Tap OK.

## Defining a custom currency symbol

If the currency you want to use is not in the list of countries, you can create your own custom country and currency symbol.

To define a custom currency symbol:

1. Tap the Menu icon .
2. Tap Options, and then tap Custom Currencies.
3. Tap one of the four Country boxes.

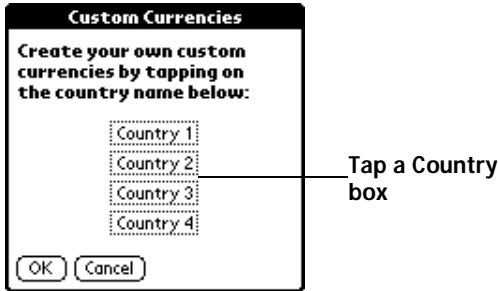

4. Enter the name of the country and the symbol that you want to appear in Expense.



5. Tap OK to close the Currency Properties dialog box.
6. Tap OK.

**Note:** If you want to use your custom currency symbol as the default for all Expense items, select the symbol in the Preferences dialog box. If you want to use your custom currency symbol only for a particular Expense item, select the symbol in the Receipt Details dialog box associated with that item.

## Show Options

Show Options define the sort order and other settings that relate to your Expense items.

To open the Show Options dialog box:

1. In the Expense list, tap Show.
2. Select any of the options.

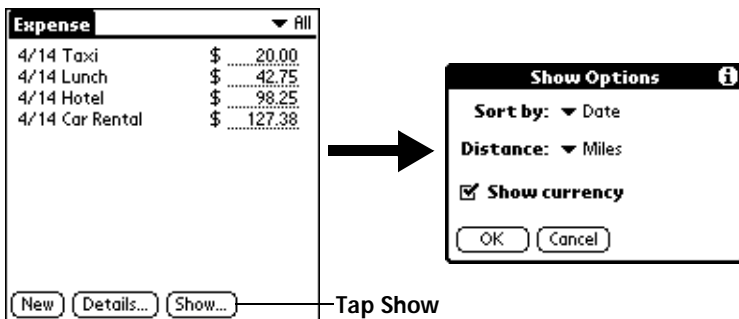

- |                      |  |
|----------------------|--|
| <b>Sort by</b>       | Enables you to sort expense items by date or type.             |
| <b>Distance</b>      | Enables you to display Mileage entries in miles or kilometers. |
| <b>Show currency</b> | Shows or hides the currency symbol in the Expense list.        |

3. Tap OK.

## Transferring your data to Microsoft Excel

After you enter your expenses into the Expense application on your organizer, Palm Desktop software enables you to view and print the data with your computer.

**Note:** You need Microsoft Excel version 5.0 (or later) to view and print your Expense data using one of the provided templates. Microsoft Excel is *not* included with the Palm IIIc organizer package. The procedures in this section also assume that you have installed Palm Desktop software. See “Palm Desktop organizer software” in Chapter 1 for more information.

## Displaying the euro on your desktop computer

When you perform a HotSync operation, the euro symbol is transferred to your Desktop application like any other piece of data on your organizer. The symbol appears in your Desktop application, however, only if you are using fonts that support the euro symbol.

These fonts are part of the operating system on your desktop computer. They do not reside with your Desktop application, and they are not produced by Palm Computing.

<b>Operating System</b>	<b>Euro Support</b>
<b>Mac OS</b>	Contained in Mac OS 8.5 or higher. For more information, visit the following web site: <a href="http://til.info.apple.com/techinfo.nsf/artnum/n22222">http://til.info.apple.com/techinfo.nsf/artnum/n22222</a>
<b>Windows 95</b>	Download free font upgrades from the Web. For more information, visit the following web site: <a href="http://www.microsoft.com/windows/euro.asp">http://www.microsoft.com/windows/euro.asp</a>
<b>Windows 98</b>	Includes all the necessary fonts and drivers.
<b>Windows NT 4.0</b>	Download free font upgrades from the Web. For more information, visit the following web site: <a href="http://www.microsoft.com/windows/euro.asp">http://www.microsoft.com/windows/euro.asp</a>

## Printing the euro

Even with operating system support, problems may arise while printing documents that contain the euro. When a font is present on both the printer and the computer, the printer font is used by default to increase printing speed. If the printer font does not include the euro, a box prints instead of the euro symbol.

You can work around this problem by sending a bitmap image of the euro to the printer or by not using the printer's built-in fonts (if allowed).

## Creating or printing an expense report

Palm Desktop software makes it quick and easy to view and print your Expense data in a Microsoft Excel spreadsheet.

**To create or print an expense report:**

1. Perform a HotSync operation to transfer your latest Expense data to your computer.

2. Click Expense in Palm Desktop software to open Microsoft Excel and the Expense Report configuration dialog box.

**Note:** If you launch Expense from the Start menu instead of Palm Desktop software, you must first choose your organizer user name.

3. Click the expense category that you want.

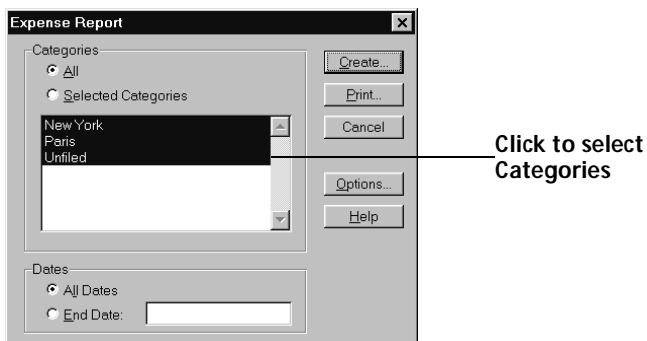

**Tip:** You can press Ctrl+click to select multiple categories. To print the expenses associated with all of your Expense categories, select All in the Categories group.

4. If you want to define an end date for the expense report, enter the date in the End Date box.

**Note:** If you do not specify an end date, all expense entries for the selected categories appear — up to the date of the last HotSync operation.

5. Do one of the following:

Click Print to display the expense report in the Print Preview window, and then click Print in the Microsoft Excel window to print your expense report.

Click Create to display a Microsoft Excel spreadsheet containing your expense data. Your data appears in Microsoft Excel spreadsheet form. You can enter information, make formatting changes, and save and print the file in the normal manner.

## Using expense report templates

Palm Desktop software includes several expense report templates. When you use one of these templates, you can edit your expense data in Microsoft Excel.

The templates have the extension .xlt and are stored in the template folder in the Palm Desktop software directory on your computer. To see what a template looks like before you use it, open the template in Microsoft Excel. For example, the template Sample2.xlt looks like this:

The screenshot shows a Microsoft Excel spreadsheet titled "Sample2.xlt". The spreadsheet is a form for an expense report. It has a grid with columns numbered 1 through 25 and rows numbered 1 through 63. The form is organized into sections: "TRAVEL EXPENSE REPORT" (rows 2-3), "LODGING" (rows 12-15), "MEALS" (rows 18-21), "BUSINESS" (rows 24-27), "TRANSPORTATION" (rows 30-37), and "MISCELLANEOUS" (rows 40-45). Each section has columns for dates and amounts. The "TOTAL" row (row 47) summarizes the expenses. Below the "TOTAL" row, there are fields for "Less cash advance", "Due employee", and "Due company". At the bottom, there are fields for "Representative", "Employer", and "Date".

If you want to streamline or customize your expense reports, you can change these templates. For example, you can add your company name to a template. See Appendix C for information on changing templates.

To view your expense data using a Microsoft Excel template:

1. Display your expense data in a Microsoft Excel spreadsheet as described in the previous procedure.
2. Click Options.

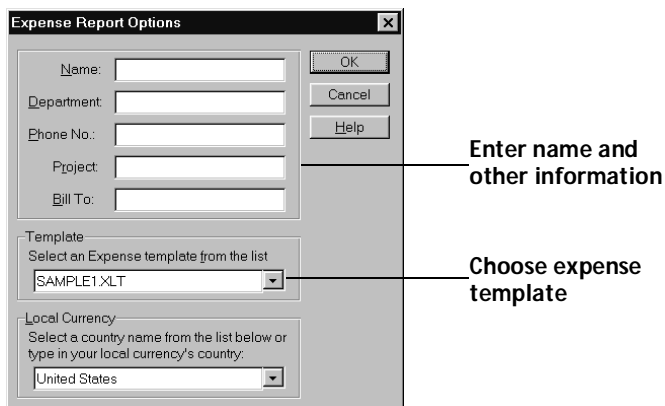

3. Enter name, department, and other information as necessary for your expense report.
4. Click the Templates menu; then select an expense template.

**Note:** If you want to create your own custom expense template and have it appear in the Templates menu, see Appendix C for more information.

5. Click OK.

## Expense menus

Expense menus are shown here for your reference, and Expense features that are not explained elsewhere in this book are described here.

See “Using menus” in Chapter 1 for information about choosing menu commands.

## Record menu

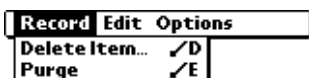



## Options menu



## Preferences

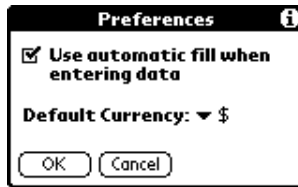

- **Use automatic fill.** Lets you select an expense type by writing the first letter of an expense type in the Graffiti writing area. For example, if you write the letter “T,” it enters the “Taxi” expense type. Writing “T” and then “E” enters “Telephone” which is the first expense type beginning with the letters “TE.”

**About Expense** Shows version information for Expense.



## Chapter 5

# Communicating Using Your Organizer

The previous chapter described the features of your Palm IIIc™ organizer that help you stay organized. This chapter describes the features that help you stay connected.

- **Managing desktop E-Mail:** Using your organizer, you can read, reply to, compose, and delete e-mail from your desktop E-Mail application while you're away from your desk.
- **IR beaming:** The infrared port located at the top of your organizer lets you send data from your organizer — including entire applications — to any other Palm Computing® platform handheld that's close by and also equipped with an IR port.

## Managing desktop E-Mail away from your desk



Mail lets you manage the e-mail that you send and receive through the E-Mail application on your desktop computer. You can read, reply to, compose, and delete e-mail on your organizer; but to send or receive e-mail, you must perform a HotSync® operation either directly or indirectly. Direct methods include placing your organizer in the cradle attached to your computer, or using infrared communications. Indirect methods include using a modem, or using network HotSync technology.

The key to Mail is that it truly synchronizes the mail in the Inbox of your desktop E-Mail application with the mail on your organizer. For example, if you delete e-mail items from Mail, your next HotSync operation also deletes the e-mail items from your desktop E-Mail application, so you never have to delete e-mail items twice. Similarly, if you read an e-mail item on your organizer and leave it in your Inbox, your next HotSync operation marks it as read in your desktop E-Mail application.

## In Mail, you can do the following:

- View, delete, file, and reply to incoming mail.
- Create outgoing e-mail items and drafts of e-mail items.
- Create simple or complex filters, which allow you to decide the type of e-mail that your organizer retrieves from your desktop E-mail application.
- Use your organizer to send and retrieve e-mail items from your desktop E-Mail application via the cradle or infrared communications.

## Setting up Mail on the desktop

Before you use Mail for the first time, make sure your desktop E-Mail application is up and running. You must also set up Palm™ Desktop software for use with your desktop E-Mail application.

Your organizer supports a number of desktop E-Mail applications, such as Microsoft Exchange (version 4.0 or higher), QUALCOMM Eudora (version 3.0.3 or higher), and Lotus cc:Mail (versions 2.5, 6.0, and 7.0). You can see the full list of the supported applications when you set up Mail.

If your desktop E-Mail application does not appear on the list, you may still be able to manage your desktop E-Mail application from your organizer by means of special connection software, called a conduit, that lets you synchronize your desktop E-Mail application and your organizer. Contact the vendor of your E-Mail application or visit the web site <http://www.palm.com> for more information.

**Note:** The following instructions assume that you have already installed Palm Desktop software on your computer and that you did not set up Mail during the installation. If you have not yet installed the Palm Desktop software, the installation procedure prompts you to set up Mail as part of the Palm Desktop software installation.

### To set up Mail:

1. Click Start in the Windows taskbar.
2. Highlight Programs, highlight Palm Desktop software, and then click Mail Setup to begin setup.
3. Follow the instructions onscreen to set up your organizer for use with your desktop E-Mail application.

### To select HotSync options:

1. Click the HotSync icon ™ in the Windows system tray (bottom-right corner of the taskbar).
2. Choose Custom.

**Tip:** You can also choose Custom from the HotSync menu in Palm Desktop software.

3. Select Mail in the list box.
4. Click Change.

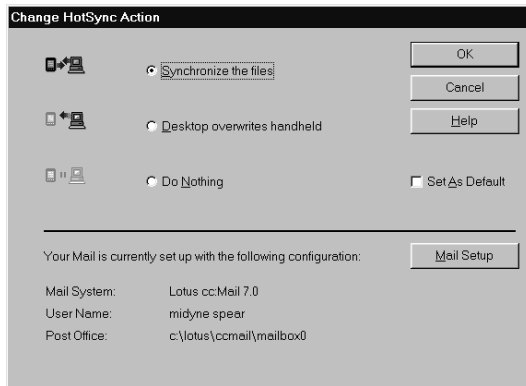

5. Click one of the following settings:

**Synchronize the files** Synchronizes the mail on your organizer and your desktop E-Mail application.

**Desktop overwrites handheld** Replaces the mail on your organizer with the mail in your desktop E-Mail application. You should use this option only if, for some reason, the two inboxes get out of sync.

**Do Nothing** Turns off communication between your organizer and desktop E-Mail application.

**Note:** Changing the HotSync setting from the default affects only the *next* HotSync operation. Thereafter, the HotSync Action reverts to the default setting.

## To change your Mail setup options:

1. Click the HotSync icon  in the Windows system tray.
2. Choose Custom.

**Tip:** You can also choose Custom from the HotSync menu in Palm Desktop software.



3. Select Mail in the list box.
4. Click Change.
5. Modify your settings as needed.
6. Click OK.

## Synchronizing Mail with your E-Mail application

After you enable and configure Mail, you need to perform a HotSync operation to synchronize Mail with your desktop E-Mail application. For a complete explanation of HotSync technology, see Chapter 6.

## Opening the Mail application on your organizer

### To open Mail:

1. Tap the Applications icon .
2. Tap the Mail icon .

## Viewing e-mail items

The Message list displays a list of your incoming e-mail items, who sent them, and the date they were received. E-mail items you've read have a check next to them. High-priority e-mail items appear in bold.



Previously read

### To open an e-mail item:

- Tap an e-mail item to open it.

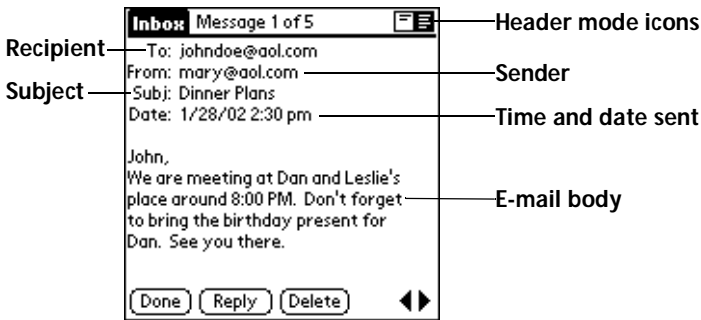

### To close an e-mail item:

- Tap Done to close the e-mail item.

### Displaying full header information

By default, Mail displays abbreviated header information, which comprises only the From: and Subj: fields. The full header provides complete information about the sender, receiver, and copied recipients, in addition to the subject and date the e-mail item was created. Mail uses the header type you select for all your e-mail items.

### To display full header information:

1. Open an e-mail item.
2. Tap the Complete Header icon.

**Tip:** To redisplay the abbreviated header, tap the Abbreviated Header icon.

## Creating e-mail items

You create e-mail items with your organizer the same way you create e-mail with your desktop E-mail application: you identify the recipient(s) of the e-mail item, define a subject, and create the body of the e-mail item.

You create original e-mail items and replies in the New Message screen. All e-mail items must, at the very least, contain information in the To: and Subj: fields.

**To create an e-mail item:**

1. Tap New.

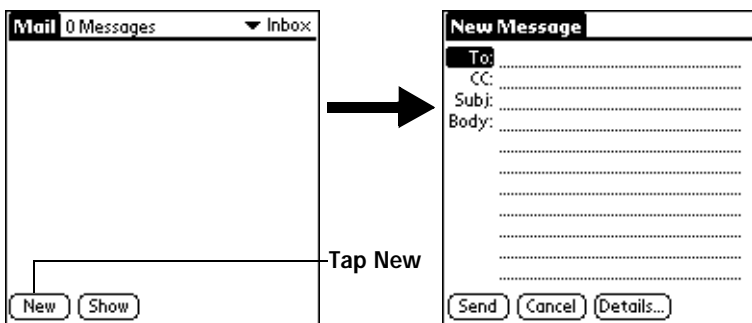

**Tip:** You can also create an e-mail item by tapping New from the Message menu.

2. Enter the e-mail address of the recipient.



**Note:** Enter the address as if you were entering it from your desktop E-Mail application. For example, network users sending an e-mail item to a user on the same network do not need to add Internet information, such as @mycorp.com.

3. To send a copy of this e-mail item to additional recipients, tap the CC: field, and then enter the e-mail addresses of the additional recipients, separating the addresses with a comma followed by a space.
4. Tap the Subj: field and enter a subject for your e-mail item.
5. Tap the Body: field and enter the text of your e-mail item.



**Tip:** If the address, CC, subject, or body exceeds the capacity of the screen display, tap the name of the field (for example, tap “To:”) to expand that field. Tap the Done button to return to the New Message screen.

Tap the name of the field to open

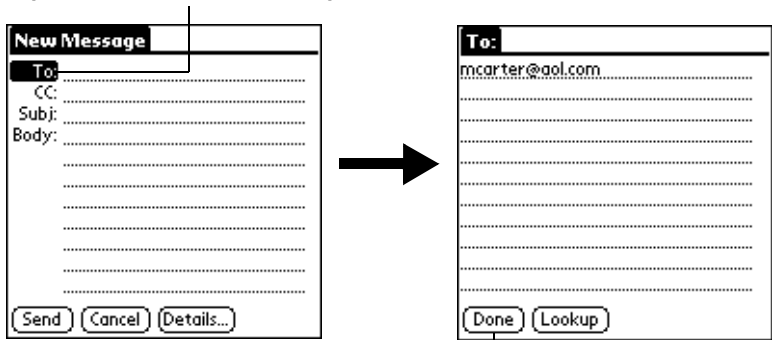

Tap to return to New Message screen

To reply to an e-mail item:

1. Tap an e-mail item in the Message list to display it onscreen.
2. Tap Reply.
3. Select whom you want to receive the reply: Sender only, All recipients, or someone who didn't see the original e-mail item (Forward).



4. Select whether you want to include original text or comment original text.
5. Tap OK.
6. Enter the text of your reply.

**Tip:** You have several options including setting the priority. See “Adding details to e-mail items” later in this chapter.

7. Tap Send to place your reply in the Outbox.

## Looking up an address

To identify the recipient of an e-mail item, you need to enter that person's e-mail address. You can do this either by entering the data directly into the field or by using the Look Up command to access the information in your Address Book.

**To look up an e-mail address:**

1. Tap either the To: or CC: field name to expand it.
2. Enter the first few letters of the last name of the person whose address you want to find.
3. Tap Lookup.
4. If the letters you enter identify a unique listing from your Address Book, your organizer completes the address for you. If not, the Lookup dialog box appears and lists all records that contain information in an E-mail field.

**Tip:** You can also open the Look Up dialog box in the New Message screen by tapping Lookup from the Options menu or by using the Graffiti® Command stroke /L.

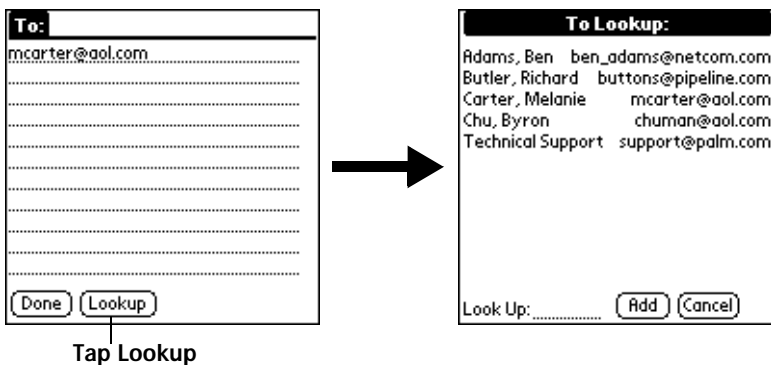

5. Enter the first letter of the entry you want to find to scroll to the first entry that begins with that letter. If you write an additional letter, the list scrolls to the first entry that starts with those two letters. For example, writing an "s" scrolls to "Sanders," and writing "sm" scrolls to "Smith."
6. Tap an address to select it.
7. Tap Add.

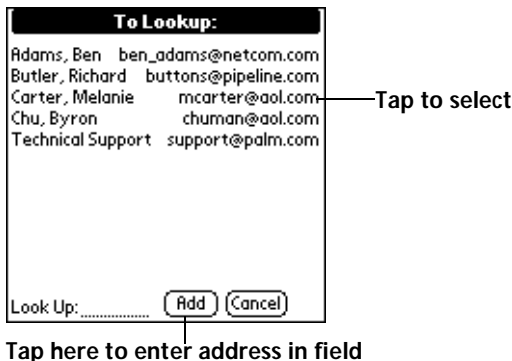

## Adding details to e-mail items

Before you send your e-mail item, you can attach additional attributes to it, such as a signature or a priority level. These features are dependent on the desktop E-mail application you use. If your application does not support the attribute you select, your organizer cannot attach that attribute to the e-mail item.

The following details are available:

- |                         |  |
|-------------------------|--|
| <b>Priority</b>         | Flags an e-mail item as High, Normal, or Low priority.   |
| <b>BCC</b>              | Creates a blind carbon copy field in the New Message screen.   |
| <b>Signature</b>        | Attaches previously defined text as the closing of an e-mail item. See “Adding a signature to your e-mail item” later in this chapter. |
| <b>Confirm Read</b>     | Requests a confirmation telling you when the e-mail item was read.   |
| <b>Confirm Delivery</b> | Requests a confirmation telling you when the e-mail item was delivered.  |

The Priority and BCC settings are valid only for the current e-mail item and must be set for each item you create.

## Setting a priority

To set a priority for your e-mail item:

1. In the New Message screen, tap Details.

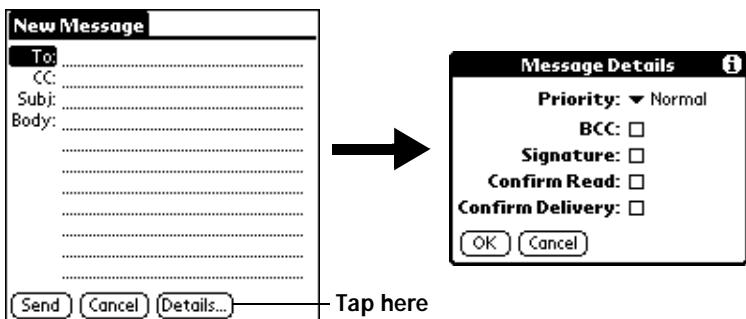

2. Tap the Priority pick list and select the priority you want.

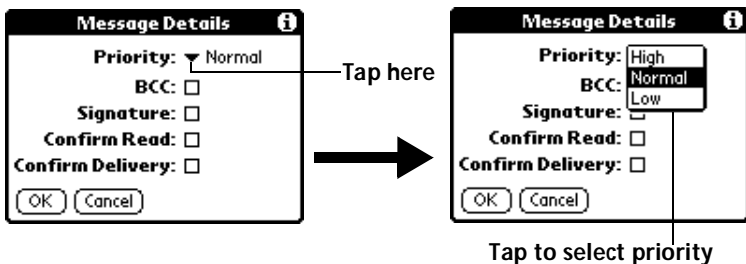

3. Tap OK.

**Tip:** Your organizer can flag e-mail items with a specific priority only if your desktop E-Mail application supports this feature.

## Sending a blind carbon copy

To add a BCC field to your e-mail item:

1. In the New Message screen, tap Details.
2. Tap the BCC check box to select it.
3. Tap OK.

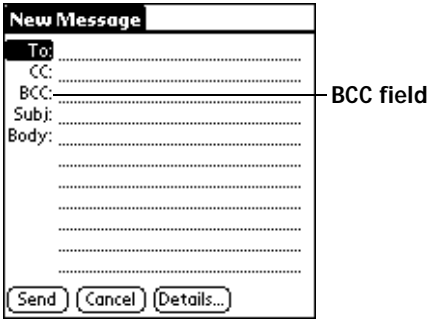

4. Tap the BCC: field and enter an address.

### Adding a signature to your e-mail item

A signature consists of information about yourself that is appended to your e-mail item as its closing. For example, a signature can contain your name, address, phone and fax numbers, and any other text you want to include. By defining such information as a signature, you save yourself the trouble of having to enter it every time you create an e-mail item.

Adding a signature to your message is a two-part process. First, you create your signature. Then you select the Signature option.

To create a signature:

1. Tap the Menu icon .
2. Tap Options, and then tap Preferences.
3. Tap the Signature text field and enter the text of your signature.

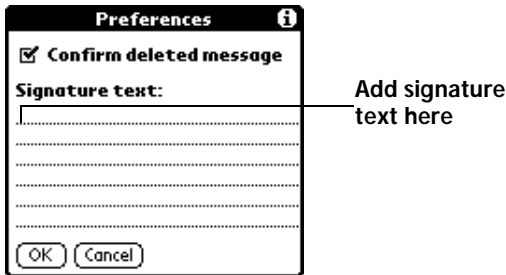

4. Tap OK.

### To add a signature to your e-mail item:

1. In the New Message screen, tap Details.
2. Tap the Signature check box to select it and add your signature to the e-mail item.

**Note:** The check box stays selected, so all subsequent e-mail items you create will also contain your signature until you deselect the Signature option.

3. Tap OK.

**Note:** The signature does not display in your e-mail item; only your recipient sees the signature.

### Requesting confirmations

#### To receive a confirmation when your e-mail item is read:

1. In the New Message screen, tap Details.
2. Tap the Confirm Read check box to select it.
3. Tap OK.

#### To receive a confirmation when your e-mail item is delivered:

1. In the New Message screen, tap Details.
2. Select the Confirm Delivery check box to select it.
3. Tap OK.

### Storing e-mail to be sent later

When you send e-mail from your organizer, it actually stores the e-mail in the Outbox folder until the next time you synchronize your organizer with your computer. During synchronization, all e-mail stored in the Outbox folder is transferred to the Outbox folder in your desktop E-Mail application. E-mail created on your organizer is sent out the next time you send mail from your desktop E-Mail application.

#### To send e-mail:

- After you create an e-mail item, tap Send.

### Editing unsent e-mail

You can make changes to an e-mail that has not yet been sent, as long as you have not yet performed a HotSync operation. When you edit an e-mail item, your organizer removes the item from the Outbox folder and takes you back to the New Message screen, where you can edit the item and resend it, save it as a draft, or delete it.

## To retrieve an e-mail item:

1. In the Message list, tap Outbox from the pick list in the upper-right corner.

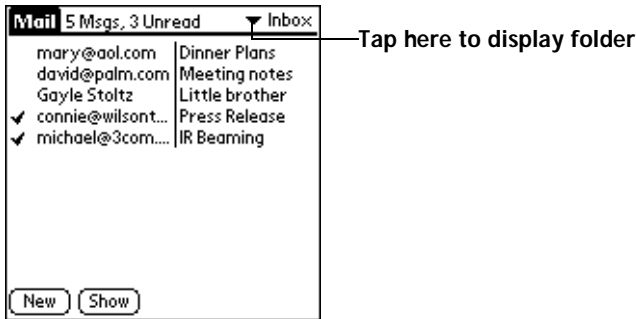

2. Tap the e-mail item you want to retrieve.

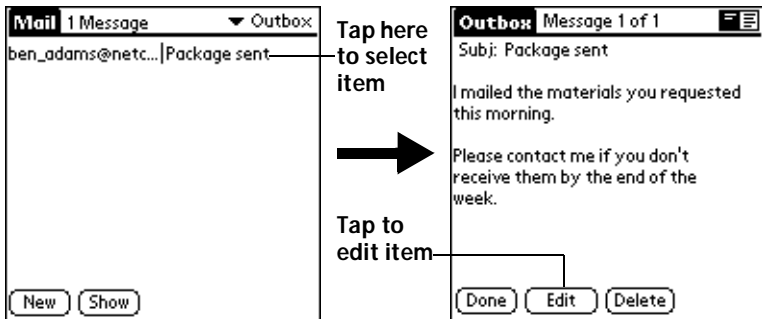

3. Tap Edit.

## Draft e-mail

Sometimes you may not want to send an e-mail item immediately; for example, you may want to add additional information before sending it. Your organizer stores such e-mail items in the Draft folder until you are ready to edit them again.

**Note:** When you're creating or editing an e-mail item, you can also save the item as a draft by canceling it. When you cancel an item, your organizer opens a dialog asking if you want to save the e-mail item. If you tap Yes, your organizer saves the item in the Draft folder.

### To save an e-mail item as a draft:

1. Create an e-mail item.
2. Tap the Menu icon .
3. Tap Message, and then tap Save Draft.

### To edit an e-mail item saved as a draft:

1. In the Message list, tap Draft from the pick list in the upper-right corner.
2. Tap the draft you want to display.

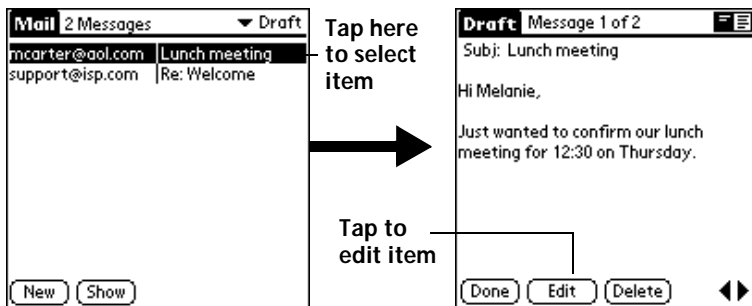

3. Tap Edit.
4. Enter your changes; then either save the e-mail item again as a draft, or tap Send to move the item to your Outbox folder.

## Filing e-mail

Your organizer can store e-mail you receive or create in the Filed folder. The contents of this folder do not automatically synchronize with your desktop E-Mail application during a HotSync operation. Your organizer, however, stores a backup copy of the Filed folder on your computer hard disk.

### To file e-mail:

1. Open an e-mail item.
2. Tap the Menu icon .
3. Tap Message, and then tap File.
4. Tap No to save the e-mail item and move it to the Filed folder, or tap Yes to file the item and keep a copy in the Inbox.



**To remove e-mail from the Filed folder:**

1. In the Message list, tap Filed from the pick list in the upper-right corner.
2. Tap the e-mail item you want to restore.
3. Tap Edit to display and modify the item.

**Tip:** After you display and modify the e-mail item, you can send it, save it as a draft, or return it to the Filed folder.

**Deleting e-mail**

Your organizer stores deleted e-mail in the Deleted folder until you perform the next HotSync operation. If you delete an e-mail item from the organizer, it is also deleted from your desktop E-Mail application when you perform the next HotSync operation.

**To delete e-mail:**

1. Open the e-mail item you want to delete.
2. Tap Delete.
3. If you selected the Preferences option to confirm deletion, tap Yes.

**Removing e-mail from the Deleted folder**

You can reverse the deletion of an e-mail item (by removing it from the Deleted folder) as long as you have not performed a HotSync operation or purged the contents of the Deleted folder.

**To remove an e-mail item you received from the Deleted folder:**

1. In the Message list, tap Deleted from the pick list in the upper-right corner.
2. Tap the e-mail item you want to restore.
3. Tap Undelete to move the selected item to the Inbox and mark it as read.

**To remove an e-mail item you created from the Deleted folder:**

1. In the Message list, tap Deleted from the pick list in the upper-right corner.
2. Tap the e-mail item you want to restore.
3. Tap Edit to display and modify the item.

**Note:** After you display and modify the e-mail item, you can send it or save it as a draft.

## Purging deleted e-mail

Because your organizer stores deleted e-mail in the Deleted folder until you perform a HotSync operation, deleted e-mail can monopolize storage space. To avoid or correct this problem, purge the contents of your Deleted folder. E-mail that you purge is still deleted from your desktop E-Mail application when you perform the next HotSync operation.

**To purge the contents of the Deleted folder:**

1. Tap the Menu icon .
2. Tap Message, and then tap Purge Deleted.
3. Tap Yes.

**Note:** You cannot restore e-mail items after you purge them.

## Message list options

Message list options enable you to manage the way the Message list displays information.

### Folders

Your organizer provides folders for categorizing your mail. The Message list displays the e-mail items in the folder you select.

**To select a folder:**

1. Tap the pick list in the upper-right corner to open the list of folders:

<b>Inbox</b>	Contains the e-mail from your desktop E-Mail application Inbox, minus any that you have excluded using filtering options. See “Creating special filters” later in this chapter.
<b>Outbox</b>	Contains the e-mail you created and sent on the organizer since the last HotSync operation.
<b>Deleted</b>	Contains the e-mail you deleted since the last HotSync operation.
<b>Filed</b>	Contains the e-mail you want to store on the organizer.
<b>Draft</b>	Contains the e-mail you created using the organizer but are not yet ready to send.

2. Select the folder you want to display in the Message list screen.

## Date column

The Date column is optional in the Message list. By default, the Date column is hidden to increase the available screen space.

To show the Date column:

1. In the Message list, tap Show.

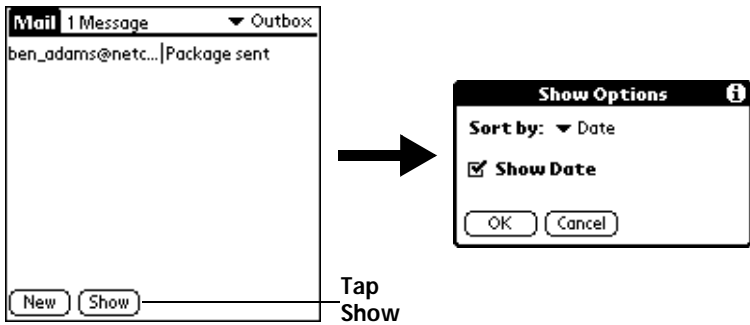

2. Tap the Show Date check box to select it.
3. Tap OK.

## Sorting the Message list

You can sort e-mail items by the date sent, by sender, or by subject.

**Note:** High-priority e-mail items always appear first, no matter how you sort the list.

To sort the Message list:

1. In the Message list, tap Show.
2. Tap the Sort by pick list and select one of the following options:

<b>Date</b>	Sorts e-mail by date and displays the most recent e-mail item at the top of the screen.
<b>Sender</b>	Sorts e-mail by the sender's user name and displays items in ascending alphabetical order, based on the first word of the From: field.
<b>Subject</b>	Sorts e-mail by the subject and displays items in ascending alphabetical order, based on the first word of the Subj: field.

3. Tap OK.

## HotSync options

HotSync options enable you to manage your e-mail more effectively by selecting which e-mail items download when you synchronize your computer and your organizer. You can define different settings for local and remote synchronization. For example, you may want to download all of your e-mail during local synchronization and only urgent e-mail during remote synchronization. Once defined, your organizer determines if synchronization is occurring locally or remotely and uses the appropriate settings for the HotSync operation.

To open the HotSync Options dialog box:

1. Tap the Menu icon .
2. Tap Options, and then tap HotSync Options.
3. Tap the Settings for pick list and select Local HotSync or Remote HotSync.

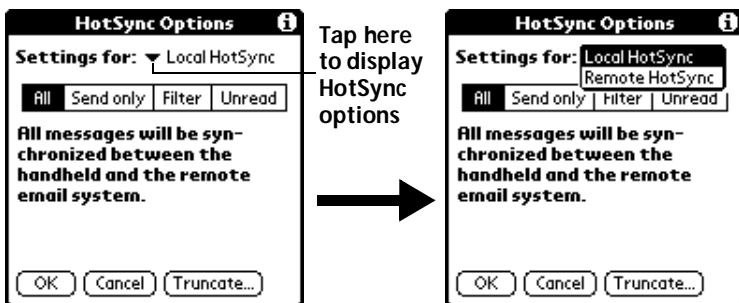

**Note:** For more information about Local and Remote HotSync operations, see Chapter 6.

4. Tap the filtering option you want to apply:

**All** During synchronization, all e-mail items in your desktop E-Mail Inbox synchronize with your organizer, and all e-mail items in your organizer Outbox are sent to your desktop E-Mail application.

**Send Only** During synchronization, only the e-mail items in your organizer Outbox are sent to your desktop E-Mail application; from there, they are sent to their destinations.

- Filter** During synchronization, all e-mail items in your organizer Outbox are sent to your desktop E-Mail application, and items in your desktop E-Mail Inbox that meet specific criteria download to your organizer. When you select the Filter setting, the HotSync Options dialog box opens and displays additional filter settings. See “Creating special filters” later in this chapter.
- Unread** During synchronization, only unread e-mail items download to your organizer from your desktop E-Mail Inbox, and all items in your organizer Outbox are sent to your desktop E-Mail application.

The All setting does not mean that all information included in each e-mail item downloads to your organizer. Truncation settings (explained in a following section) for long e-mail items still apply. Also, Mail never downloads any attachments to your organizer. The e-mail item and any text information appear, but the attachment is left in your desktop E-Mail application.

5. If you selected All, Send only, or Unread, tap OK. If you selected Filter, continue to the next section.

## Creating special filters

You can create special filters to control the type of e-mail items that download to your organizer during synchronization. Special filters work on the premise of ignoring or retrieving items that contain specific information in their header fields.

To create a special filter, you must decide whether you want to ignore or retrieve certain e-mail items. Then, based on that decision, you must tell your organizer what it needs to look for in the To:, From:, and Subj: fields to single out those e-mail items.

To access the special filter settings:

- Tap the Filter box in the HotSync Options dialog box.

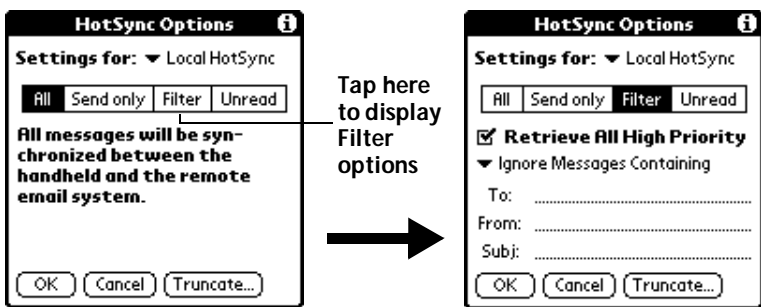

## Ignoring or receiving e-mail

The first step in establishing a special filter is to determine whether you want to ignore or retrieve e-mail that matches the information you specify.

To define whether to ignore or receive e-mail:

- Tap the pick list in the center of the HotSync Options dialog box and select one of the following settings:

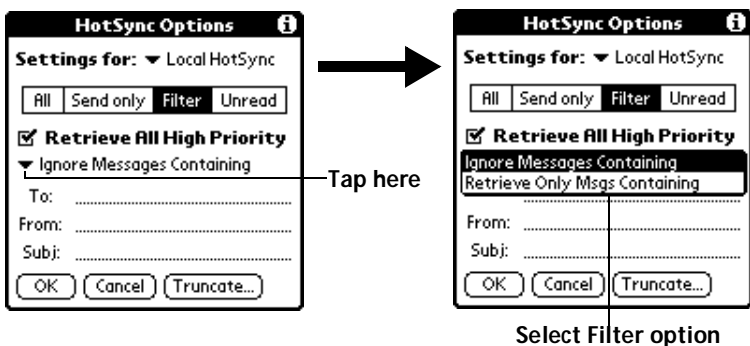

### Ignore Messages Containing

Tells your organizer to *exclude* the e-mail items that meet the criteria you define and download *all other e-mail items* during synchronization. In general, this filter downloads more e-mail during synchronization because it blocks only one defined subset of e-mail.

**Retrieve Only Msgs Containing** Tells your organizer to *include* only the e-mail items that meet the criteria you define and to ignore all other e-mail items during synchronization. This filter has the potential to block more e-mail during synchronization because it downloads only one subset of e-mail.

## Defining filter strings

E-mail items are filtered based on the information contained in their To:, From:, and Subj: fields. The information that defines what your organizer is looking for is called a *filter string*. You create a filter string by listing the words you want your organizer to find and separating them with either a comma or a space. Each word in the filter string is joined by an implicit OR, so you do not need to enter logical connectors like AND or OR.

To create a more complex filter, you can define filter strings for the To:, From:, and Subj: fields simultaneously. Your organizer joins the filter strings for these fields using an implicit AND; once again, you do not need to add the logical connector. Your organizer does that for you.

For example, suppose you want to receive only e-mail items from John Smith (jsmith@aol.com) or Jack Jones (jjones@aol.com) concerning the Apollo Project. You would create the following filter strings:

In the To: field: jsmith@aol.com, jjones@aol.com

In the Subj: field: Apollo Project

Your organizer interprets this as, “Accept e-mail items about the Apollo Project from John Smith or Jack Jones. Do not accept e-mail items from other people. Do not accept e-mail items from John or Jack about any other subject.”

When you define a string, note that your organizer searches for any instance of that *sequence* of characters. For example, if you create a filter that retrieves only e-mail items containing the string “info,” your organizer considers “**info**,” “**rainforest**” and “**kinfolk**” appropriate matches.

To define a filter string:

1. Tap a header field in the HotSync Options dialog box.

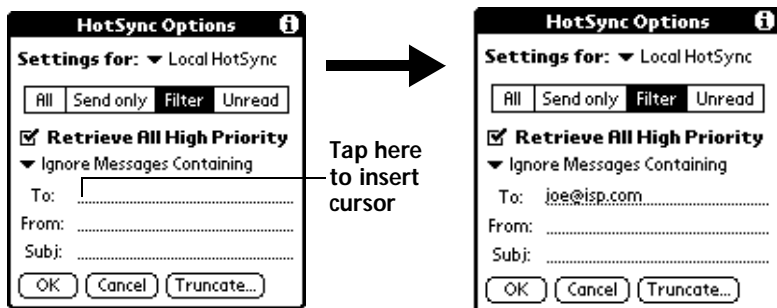

2. Enter your filter string, using commas or spaces to separate the words. Do not add connectors, such as AND or OR, between words in a string.
3. If your string exceeds the length of the field, tap the name of the field to display the Notes screen for that header field. For more information about header field Notes screens, see “Creating e-mail items” earlier in this chapter.

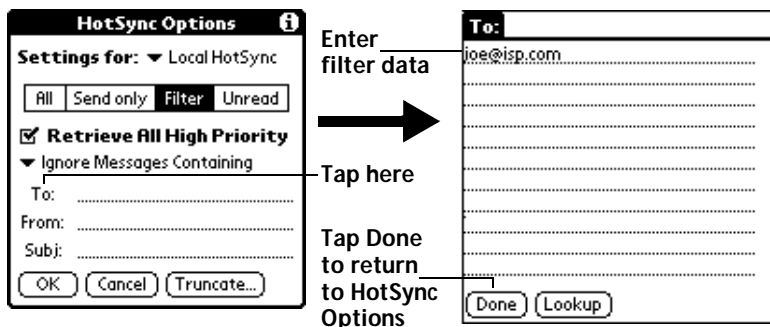

4. Tap Done to return to the HotSync Options dialog box.
5. Tap OK.

## High-priority e-mail

The Retrieve All High Priority setting lets you retrieve e-mail items marked high-priority, even if those items would have been blocked by a defined filter.

To retrieve high-priority e-mail items:

1. Tap the Filter box in the HotSync Options dialog box.



2. Tap the Retrieve All High Priority check box to select it.

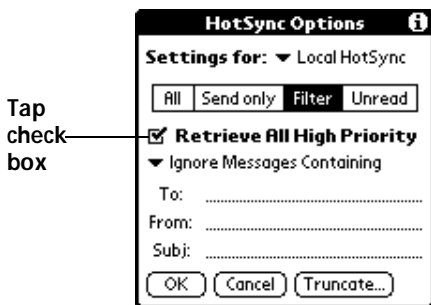

3. Tap OK.

**Note:** This setting is applicable only if your E-Mail application has the capacity to flag high-priority e-mail items.

## Truncating e-mail items

The Truncate feature lets you set a point at which long e-mail items truncate when downloading to your organizer. By default, this Truncate value is 4,000 characters. By truncating long messages, you reduce the time it takes to synchronize your desktop E-Mail and Mail, as well as the amount of storage space e-mail uses on your organizer.

**Note:** Truncation is separate and independent from filtering.

To truncate e-mail items:

1. Tap Truncate in the HotSync Options dialog box.

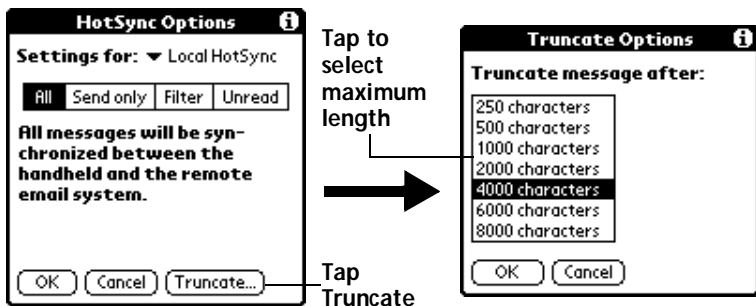

2. Tap to select the truncation setting you want.

**Tip:** If you select the maximum setting, messages can be 8,000 characters; longer messages are truncated. If you select a lower value, you'll have more room for e-mail items.

3. Tap OK.

## Mail menus

Mail menus are shown here for your reference, and Mail features that are not explained elsewhere in this book are described here.

See “Using menus” in Chapter 1 for information about choosing menu commands.

### Message menus

The Message menu varies depending on whether you are viewing an e-mail item, creating an e-mail item, or viewing the Message list.

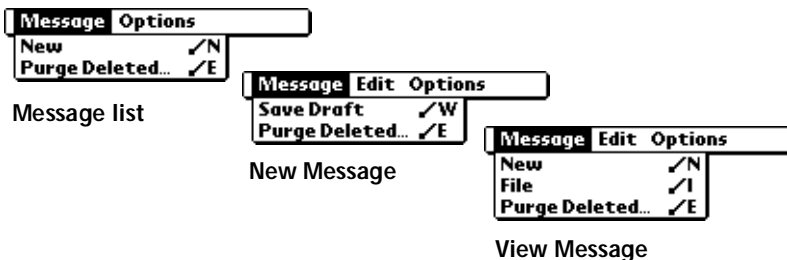

### Options menus

The Options menu varies depending on whether you are creating or editing an e-mail item.



#### About Mail

Shows version information for Mail.

## Beaming information

Your organizer is equipped with an IR (infrared) port that you can use to beam information to another Palm Computing platform handheld that's close by and also has an IR port. The IR port is located at the top of the organizer, behind the small dark shield.

You can beam the following information between Palm Computing platform handhelds:

- The record currently displayed in Date Book, Address Book, To Do List, or Memo Pad
- All records of the category currently displayed in Address Book, To Do List, or Memo Pad
- A special Address Book record that you designate as your business card, containing information you want to exchange with business contacts
- An application installed in RAM memory

**Note:** You can also perform HotSync operations using the IR port. See “IR HotSync operations” in Chapter 6 for more details.

**To select a business card:**

1. Create an Address Book record that contains the information you want on your business card.
2. Tap the Menu icon .
3. Tap Record, and then tap Select Business Card.
4. Tap Yes.

**To beam a record, business card, or category of records:**

1. Locate the record, business card, or category you want to beam.
2. Tap the Menu icon .
3. Tap Record, and then tap one of the following:
  - The Beam command for an individual record
  - In Address Book only: Beam Business Card
  - Beam Category
4. When the Beam Status dialog box appears, point the IR port directly at the IR port of the receiving organizer.

**Tip:** For best results, Palm IIIc organizers should be between 10 centimeters (approximately 4 inches) and 1 meter (approximately 39 inches) apart, and the path between the two organizers must be clear of obstacles. Beaming distance to other Palm Computing platform handhelds may be different.



5. Wait for the Beam Status dialog box to indicate that the transfer is complete before you continue working on your organizer.

**To beam an application:**

1. Open the Applications Launcher.
2. Tap the Menu icon .
3. Tap App, and then tap Beam.
4. Tap the application you want to transfer.

**Note:** Some applications are copy-protected and cannot be beamed. These are listed with a lock icon next to them.

5. Tap Beam.
6. When the Beam Status dialog box appears, point the IR port directly at the IR port of the receiving organizer.
7. Wait for the Beam Status dialog box to indicate that the transfer is complete before you continue working on your organizer.

**To receive beamed information:**

1. Turn on your organizer.
2. Point the IR port directly at the IR port of the transmitting organizer to open the Beam dialog box.
3. Select a category for the incoming information, create a new category, or leave the information unfiled.



4. Tap Yes.

### Tips on beaming information

- You can press the Address Book application button  for about two seconds to beam your business card.
- You can set the full-screen pen stroke to beam the current entry. See “Pen preferences” in Chapter 7 for more information.
- You can use the Graffiti Command stroke /B to beam the current entry.



## Chapter 6

# Advanced HotSync® Operations

HotSync® technology enables you to synchronize data between one or more Palm Computing® platform handhelds and Palm™ Desktop software or another PIM such as Microsoft Outlook. To synchronize data, you must connect your Palm IIIc™ organizer and Palm Desktop software. You can synchronize your data either directly or indirectly. Direct methods include placing your organizer in the cradle attached to your computer, or using infrared communications. Indirect methods include using a modem, or using network HotSync technology.

This chapter describes how to select HotSync options and perform a HotSync operation via infrared communications, a modem, or a network. See “Exchanging and updating data: HotSync operations” in Chapter 4 for information about performing your first and subsequent local HotSync operations.

## Selecting HotSync setup options

You can choose when you want HotSync Manager to run. If necessary, you can adjust the local and modem HotSync settings as well.

**To set the HotSync options:**

1. Click the HotSync Manager icon in the Windows system tray.
2. Choose Setup.

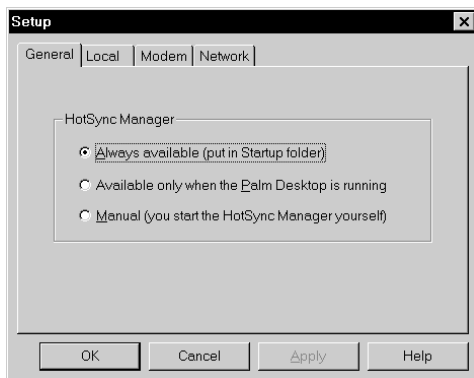

3. Click the General tab and select one of the following options:

**Always available** Adds HotSync Manager to the Startup folder and constantly monitors the communication port for synchronization requests from your organizer. With this option, the HotSync Manager synchronizes data even when Palm Desktop software is not running.

**Available only when Palm Desktop software is running** Starts HotSync Manager and monitors requests automatically when you open Palm Desktop software.

**Manual** Monitors requests only when you select HotSync Manager from the Start menu.

**Tip:** If you're not sure which option to use, keep the default setting: Always available.

4. Click the Local tab to display the settings for the connection between your computer and the organizer cradle, and adjust the following options as needed.

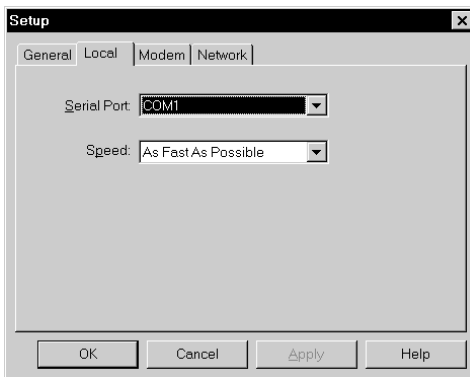



**Serial Port**

Identifies the port that Palm Desktop software uses to communicate with the cradle. This selection should match the number of the port to which you connected the cradle.

**Note:** Your organizer cannot share this port with an internal modem or other device. See “Palm IIIc components” in Chapter 1 if you have trouble identifying the serial port.

**Speed**

Determines the speed at which data is transferred between your organizer and Palm Desktop software. Try the As Fast As Possible rate first, and adjust downward if you experience problems. This setting allows Palm Desktop software and your organizer to find and use the fastest speed.

5. Click the Modem tab to display the modem settings and adjust the options as needed. See “Conducting a HotSync operation via modem” later in this chapter for more information.
6. If you are attached to a network, click the Network tab to display the network settings and adjust the options as needed. See “Conducting a HotSync operation via a network” later in this chapter for more information.
7. Click OK.

## Customizing HotSync application settings

For each application, you can define a set of options that determines how records are handled during synchronization. These options are called a “conduit.” By default, a HotSync operation synchronizes all files between the organizer and Palm Desktop software.

In general, you should leave the settings to synchronize all files. The only reason you might want to change these settings is to overwrite data on either your organizer or Palm Desktop software, or to avoid synchronizing a particular type of file because you don’t use it.

In addition to the conduits for Date Book, Address Book, To Do List, Memo Pad, and Expense, Palm Desktop software includes System and Install conduits. The System conduit backs up the system information stored on your organizer, including Graffiti® ShortCuts. The Install conduit installs add-on applications on your organizer.

To customize HotSync application settings:

1. Click the HotSync icon ™ in the Windows system tray (bottom-right corner of the taskbar).

**Tip:** You can also click the HotSync command on the Palm Desktop software menu bar.

2. From the HotSync Manager menu, choose Custom.

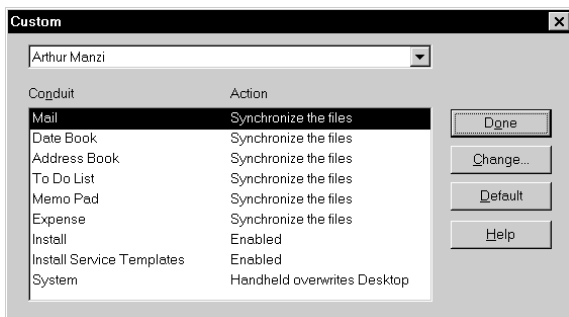

3. Select the appropriate user name from the list.
4. Select an application in the Conduit list.
5. Click Change.

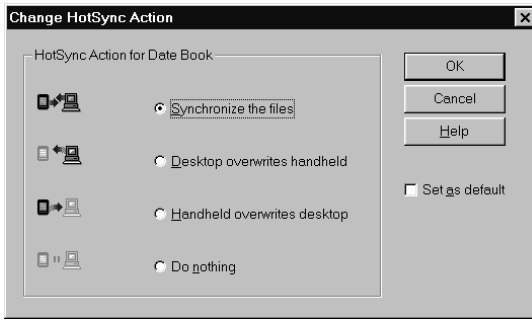

6. Click the direction in which you want to write data, or click Do Nothing to skip data transfer for an application.

**Note:** Changing the HotSync setting from the default affects only the *next* HotSync operation. Thereafter, the HotSync Actions revert to their default settings. To use a new setting on an ongoing basis, select the Set As Default box. Thereafter, whatever you selected as the default setting is used when you click the Default button in the Custom dialog.

7. Click OK.
8. Repeat steps 4 through 7 to change conduit settings for other applications.
9. Click Done to activate your settings.

## IR HotSync operations

Your organizer is equipped with an infrared (IR) port that supports the IrCOMM implementation of the standards for infrared communication established by the Infrared Data Association (IrDA). This means that not only can you beam data to another Palm Computing platform handheld that's equipped with an IR port, but you can also beam data to a cell phone and any other device that supports the IrCOMM implementation of the IrDA standards.

Most importantly, you can use the IR port to perform HotSync operations; you don't need your cradle. This is especially useful if you travel with an infrared-enabled laptop. You simply enable infrared communication on your laptop and organizer and follow the steps in "Performing an IR HotSync operation" later in this section.

### Preparing your computer for infrared communication

Before you can perform a HotSync operation using the IR port, the computer with which you want to synchronize must fulfill these requirements:

- Your computer must support the IrCOMM implementation of the IrDA standards.
- Your computer must have an enabled infrared port that's built into the computer, or an enabled infrared device attached to the computer.

Desktop computers are likely to require an infrared device attached to a physical COM port. Laptops are likely to have a built-in IR port, so no external device is necessary. Your computer must also have an installed infrared driver.

Check your computer's documentation to learn if the computer supports infrared communication. If your computer is a Macintosh G3, or uses Microsoft Windows 98, infrared communication is built into the operating system. Some versions of the Macintosh iMac also have built-in infrared communication.

The following procedure explains how to find out if your Windows 95 computer has an infrared driver installed.

**To check if your Windows 95 computer supports infrared communication:**

1. In the Windows taskbar, click Start.
2. Choose Settings, and then choose Control Panel.

3. In the Control Panel, look for the Infrared icon.

If the icon is there, your computer is enabled for infrared communication. If it isn't there, you need to install an infrared driver.

**Note:** If you have an external infrared device attached to your computer, a driver is probably included with the device. Consult the documentation included with the device for information on installing the required driver.

**To install a Windows 95 infrared driver:**

1. Click the HotSync Manager icon  in the Windows system tray and choose Setup. Click the tabs and note the COM ports being used by the HotSync Manager. You need this information later.

2. Go to this web site:

<http://www.microsoft.com/windows/downloads>

3. Follow the links to the Windows 95 IrDA 2.0 (Infrared Driver), and follow the instructions to download the driver.

4. Close your Internet browser if it's in the way.

5. Find the file W95ir.exe on your computer.

Before you go to the next step, be sure this file is in a folder where you want to store the infrared driver.

6. Double-click W95ir.exe.

A window lists the files that are unzipping onto your hard disk. When the title bar displays Finished, close this window.

7. Double-click Setup.exe to begin installation. This file is in the folder where you unzipped W95ir.exe.

The Add Infrared Device Wizard appears.

8. Click Next.

9. Accept the defaults provided until the Wizard asks you to select an infrared port. Be sure to select an available communications port. Do not select the port that the HotSync Manager currently uses.

10. Continue the rest of the installation using the defaults provided.

If an alert appears telling you that there is a communication port conflict, click OK and proceed.

After you install the infrared driver, check the ports used by your computer for infrared communication.

**To check the ports used for infrared communication:**

1. In the Windows taskbar, click Start, choose Settings, and then choose Control Panel.
2. Double-click Infrared.
3. Click the Options tab.
4. Select Enable infrared communication.



The COM port displayed in the drop-down box is the port where your infrared device is attached. It should be *different* from any port used by the HotSync Manager.

5. Make a note of which port is listed as “providing application support.” You need this information to configure the HotSync Manager for infrared communication.

This port (COM4 in this example) is the simulated port, the channel through which the actual infrared communication takes place between your computer and your organizer.

6. Deselect any other check boxes in the Options tab.
7. Click Apply and OK.

## Configuring HotSync Manager for infrared communication

Next, you need to go to the HotSync Manager and specify the simulated port used for infrared communication.

**To configure HotSync Manager for infrared communication:**

1. Click the HotSync Manager icon  in the Windows system tray.
2. Make sure Local is checked on the menu.
3. Choose Setup.
4. Click the Local tab.
5. In the Serial Port drop-down box, select the COM port that was given as the simulated port in the Options tab of the Infrared Monitor (in this example, COM4).

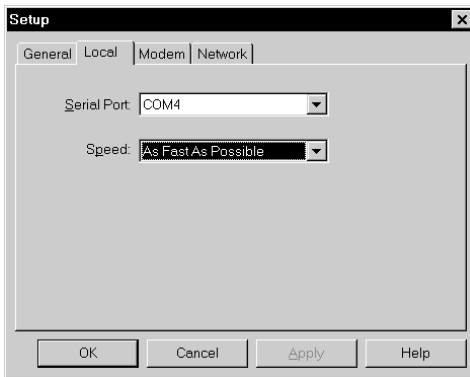

6. Click OK.

The HotSync Manager is now communicating with the simulated port defined for infrared communication. This means that you cannot use your cradle again until you reconfigure the HotSync Manager to communicate with the port defined for cradle synchronization.

## Performing an IR HotSync operation

After you complete the steps to prepare for performing an IR HotSync operation, it is easy to perform the actual operation.

**To perform an IR HotSync operation:**

1. In the Applications Launcher, tap the HotSync icon.
2. Tap Local.
3. Tap the pick list below the HotSync icon and select IR to a PC/Handheld.
4. Position the IR port of your organizer within a couple of inches of the infrared port of your computer.
5. Tap the HotSync icon to start the IR HotSync operation.

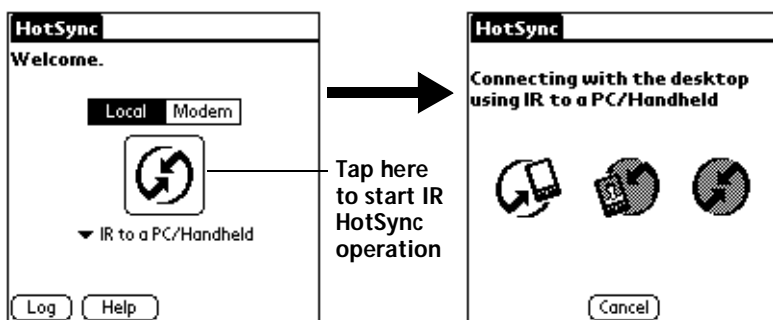

## Returning to cradle HotSync operations

It's easy to return to using the cradle for HotSync operations.

**To return to cradle HotSync operations:**

1. If needed, connect the cradle to a serial (COM) port of your computer.
2. Click the HotSync Manager icon  in the Windows system tray.
3. Choose Setup, and then click Local.
4. Select the COM port where your cradle is connected.
5. Click OK.

Now, the next time you want to perform a HotSync operation, just press the HotSync button on the cradle, as you always did in the past.



You can leave the HotSync application on your organizer set to perform IR HotSync operations and still use the cradle. This is useful if you perform HotSync operations with both your desktop computer and a laptop that you travel with. When you travel, you don't have to carry a cradle or cable because your organizer is set to perform IR HotSync operations. When you're in the office, just place your organizer in the cradle and press the HotSync button.

## Conducting a HotSync operation via modem

You can use a modem to synchronize your organizer when you are away from your computer.

**Note:** The first HotSync operation must be local, using the cradle. After that, you can perform a modem HotSync operation.

To perform a HotSync operation via modem you need the following:

- A modem connected to your computer.
- Palm Desktop software configured for use with the modem.
- A modem connected to your organizer.
- A configuration for the kind of modem connection (Serial to Modem or IrCOMM to Modem) you want to make. See "Connection preferences" in Chapter 7 for more information.

## Preparing your computer

There are a few steps you must perform to prepare your computer for a modem HotSync operation. Be sure to perform these steps before you leave your office so that your computer is ready to receive a call from your organizer.

**To prepare your computer for a modem HotSync operation:**

1. Confirm that the computer modem is connected and turned on, and that no communications applications, such as fax or telephony software, are running on a COM port.

**Note:** Make sure the computer is disconnected from all online services, such as America Online (AOL) and CompuServe. This helps to avoid conflicts with the COM port.

2. Start HotSync Manager if it is not already running, and from the HotSync Manager menu, choose Modem.
3. Adjust the following options as needed.

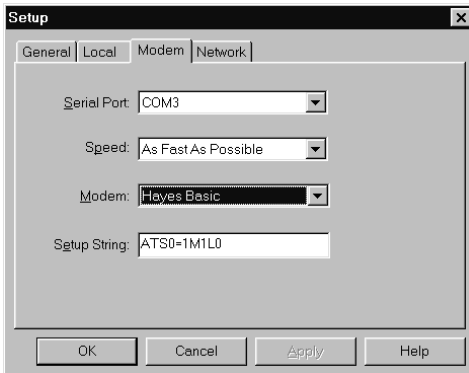



- Serial Port** Identifies the port for the modem. If you are unsure of the port assignment, look at the Modem Properties in the Windows Control Panel.
- Speed** Determines the speed at which data is transferred. Try the As Fast As Possible rate first, and adjust downward if you experience problems. This setting allows Palm Desktop software and your organizer to find and use the fastest speed.
- Modem** Identifies the modem type or manufacturer. Refer to your modem manual or face plate for its type or settings. If you're not sure of your modem type or your modem doesn't match any that appear in the list, select Hayes Basic.
- Setup String** Identifies the setup string for your particular modem. Not all modems require a setup string. Refer to your modem manual and enter the setup string if recommended by the manufacturer.

4. Click OK.

## Preparing your organizer

There are a few steps you must perform to prepare your organizer for a modem HotSync operation.

To prepare your organizer for a modem HotSync operation:

1. Tap the Applications icon .
2. Tap the HotSync icon .
3. Tap Modem.

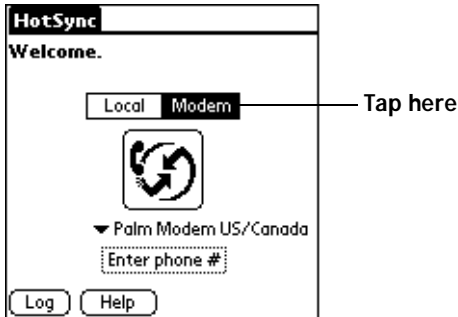

4. Tap the pick list below the icon and select a modem configuration.

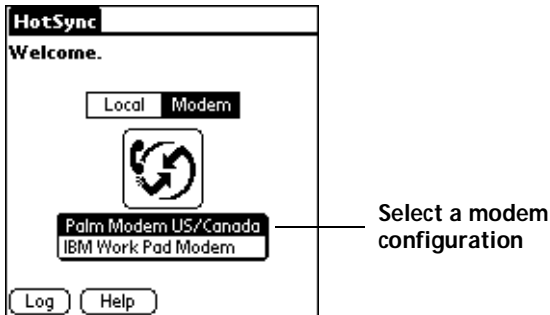

**Note:** If you need to create a configuration, tap the Menu icon and then select Options and Connection Setup. See “Connection preferences” in Chapter 7 for more information.

5. Tap the Enter phone # field.

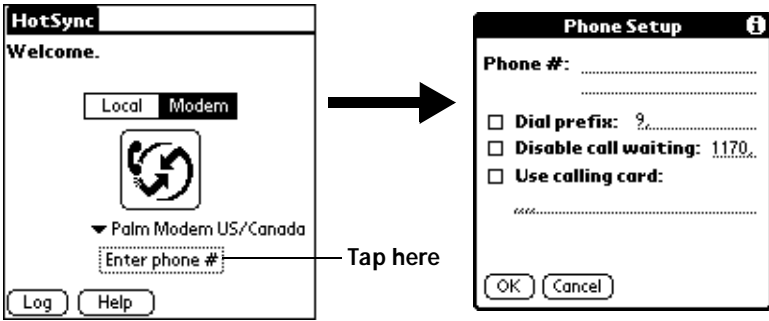

**Note:** If you plan to connect to your company’s dial-in server (network modem) instead of connecting to a computer modem, see “Conducting a HotSync operation via a network” later in this chapter.

6. Enter the telephone number to access the modem connected to your computer.
7. If needed, enter a dial prefix (such as “9”) to access an outside line, and then tap the Dial Prefix check box.



**Tip:** You can enter a comma in the field to introduce a “pause” in the dialing sequence. Each comma equals a two second pause.

8. If the phone line you’re using for the organizer has Call Waiting, select the Disable call waiting check box to avoid an interruption during the modem HotSync operation.
9. If you want to use a calling card to place the call, select the check box and enter the calling card number.
10. Tap OK.

## Selecting the conduits for a modem HotSync operation

The Conduit Setup dialog box on your organizer enables you to define which files and/or applications synchronize during a modem HotSync operation. You can use these settings to minimize the time required to synchronize data with a modem.

To change the Conduit Setup for a modem HotSync operation:

1. Tap the Applications icon .
2. Tap the HotSync icon .
3. Tap the Menu icon .
4. Tap Options, and then tap Conduit Setup.
5. Tap the check boxes to deselect the files and applications that you do *not* want to synchronize during a modem HotSync operation. The default setting is to synchronize all files.





**Note:** Applications that do not have a database (such as games) do not synchronize — even if you select the item in the Conduit Setup dialog box.

6. Tap OK.

## Performing a HotSync operation via a modem

After you prepare your computer and your organizer, and select your Conduit Setup options, you are ready to perform a modem HotSync operation.

To perform a modem HotSync operation:

1. Tap the Applications icon .
2. Tap the HotSync icon .
3. Tap the Modem icon  to dial the Palm Desktop modem and synchronize the applications.
4. Wait for the HotSync operation to complete. If you have any problems conducting a successful HotSync operation, see Appendix B.

# Conducting a HotSync operation via a network

When you use the network HotSync technology, you can take advantage of the LAN and WAN connectivity available in many office environments. The network HotSync technology enables you to perform a HotSync operation by dialing in to a network or by using a cradle that is connected to any computer on your LAN or WAN (provided that the computer connected to the cradle also has the network HotSync technology installed, your computer is on, and the HotSync Manager is running).

## Connecting to your company's dial-in server

A network HotSync operation requires the following (consult your System Administrator for assistance):

- Your computer has TCP/IP support installed.
- Both your company's network system and its remote access server support TCP/IP.
- You have a remote access account.

Everything you need to connect to your company's dial-in server (network modem) is included with Palm Desktop software and organizer software. You need to activate the feature, however, on both Palm Desktop software and your organizer.

To prepare your computer for a network HotSync operation:

1. Click the HotSync Manager icon  in the Windows system tray.
2. From the HotSync Manager menu, choose Network.

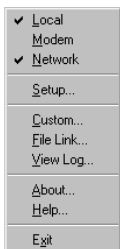

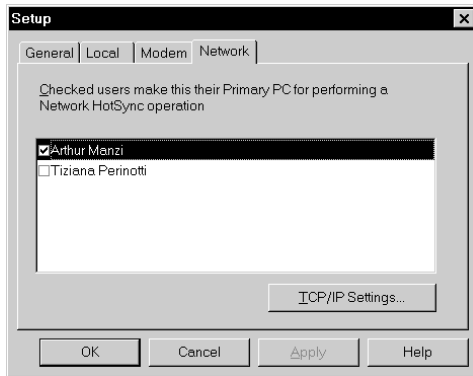

3. From the HotSync Manager menu, choose Setup.
4. Click the Network tab and make sure your user name has a check mark next to it. If the check mark is not there, click the check box next to your user name.



5. Click OK.
6. Put your organizer in the cradle and perform a HotSync operation.

The HotSync operation records network information about your computer on your organizer. With this information, your organizer can locate your computer when you perform a HotSync operation over the network.

To prepare your organizer for a network HotSync operation:

1. Tap the Applications icon .
2. Tap the HotSync icon .
3. Tap the Menu icon .
4. Tap Options, then tap Modem Sync Prefs.
5. Tap Network.

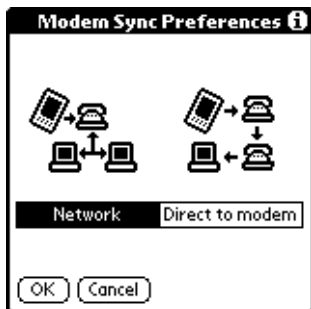

6. Tap OK.
7. Tap Select Service.

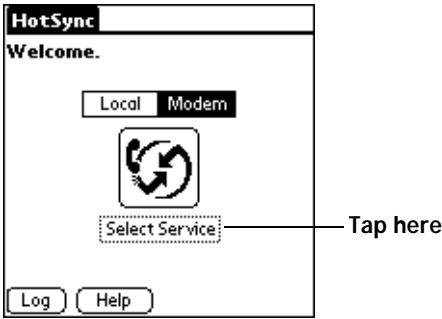

**Note:** See “Network preferences and TCP/IP software” in Chapter 7 for information on creating a network connection.

8. Tap Service and select a service.

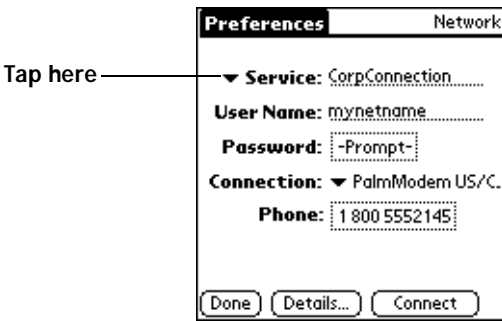

9. Tap Done.

10. Tap the Menu icon .

11. Tap Options, then tap Conduit Setup.

Follow the instructions in “Selecting the conduits for a modem HotSync operation” earlier in this chapter.



## Performing a network HotSync operation

After you prepare your computer and your organizer, and select your Conduit Setup options, you are ready to perform a network HotSync operation.

To perform a network HotSync operation:

- Tap the modem HotSync icon to begin the operation.

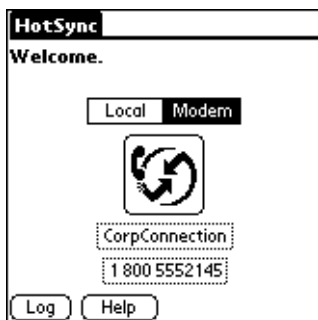

## Using File Link

The File Link feature enables you to import Address Book and Memo Pad information onto your organizer from a separate external file such as a company phone list. HotSync Manager stores the data in a separate category on your Palm Desktop software and your organizer. You can configure the File Link feature to check for changes to the external file when you perform a HotSync operation.

With File Link, you can import data stored in any of the following formats:

- Comma-separated (\*.csv)
- Memo Pad archive (\*.mpa)
- Address Book archive (\*.aba)
- Text (\*.txt)

For information on how to set up a file link, see the Palm Desktop online Help.

## Creating a user profile

If you use the File Link feature to configure several Palm Computing platform handhelds with specific information (such as a company phone list) before distributing them to their actual users, you can create a user profile to load the data into an organizer without associating that data with a user name. The User Profile feature is designed only for the first-time HotSync operation, before you assign a User ID to a particular organizer.

To create a user profile:

1. Open Palm Desktop software.
2. From the Tools menu, choose Users.
3. Click Profiles.
4. Click New.

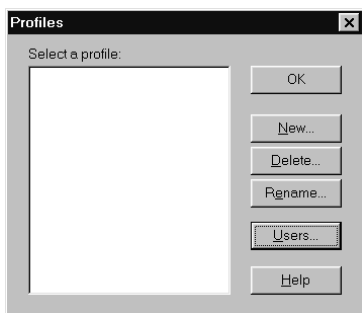

5. Enter a unique name for the profile and click OK.



6. Repeat steps 3 and 4 for each profile that you want to create, and then click OK to return to Palm Desktop software.
7. Select the profile from the User list and create the data for the profile (e.g., company phone list, etc.).

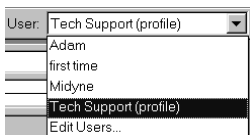

**To use a profile for the first-time HotSync operation:**

1. Place the new organizer in the cradle.
2. Press the HotSync button  on the cradle.
3. Click Profiles.
4. Select the profile you want to load on the organizer, and click OK.

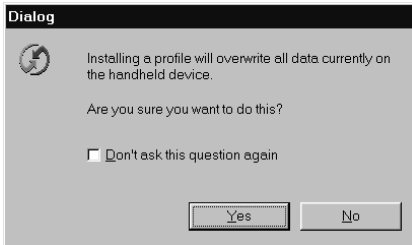

5. Click Yes to transfer all the profile data to the organizer.

The next time you perform a HotSync operation, Palm Desktop software prompts you to assign a user name to the organizer.



## Chapter 7

# Setting Preferences for Your Organizer



The Preferences screens enable you to customize the configuration options on your Palm IIIc™ organizer.

**In the Preferences screens, you can do the following:**

<b>General</b>	Set the date and time, the auto shut-off interval, the Stay on in cradle feature, the Beam Receive feature, and the system, alarm, and game sounds.
<b>Formats</b>	Set the country default and the formats for dates, times, calendar, and numbers.
<b>Connection</b>	Configure serial, modem, and infrared communication settings.
<b>Owner</b>	Assign your name, phone number, and other owner information to your organizer.
<b>Buttons</b>	Assign different applications to the buttons on the front panel of your organizer and the HotSync® button on the cradle, and reassign the full-screen pen stroke command.
<b>ShortCuts</b>	Define a list of Graffiti® abbreviations.
<b>Digitizer</b>	Calibrate the screen on your organizer.
<b>Network</b>	Configure your organizer for use with a network.

## Viewing preferences

To open the Preferences screens:

1. Tap the Applications icon .
2. Tap the Preferences icon .
3. Tap the pick list in the upper-right corner of the screen.
4. Select the Preferences screen you want to view.

# Buttons preferences

The Buttons Preferences screen enables you to associate different applications with the buttons on the front of the organizer.

For example, if you find that you seldom use To Do List and often use Expense, you can assign the To Do List button to start Expense.

Any changes you make in the Buttons Preferences screen become effective immediately; you do not have to change to a different screen or application.

If you assign a different application to a button, you can still access the original application using the Applications Launcher.

To change the Buttons preferences:

1. Tap the pick list next to the button you want to re-assign.

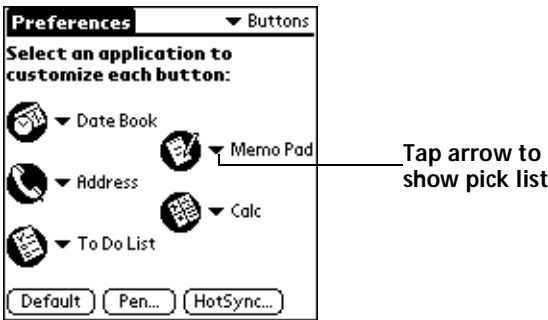

2. Tap the application that you want to assign to the button.

**Tip:** To restore all of the buttons to their factory settings, tap Default.

## Pen preferences

The Buttons Preferences screen enables you to change the assignment of the full-screen pen stroke. By default, the full-screen pen stroke activates Graffiti Help.

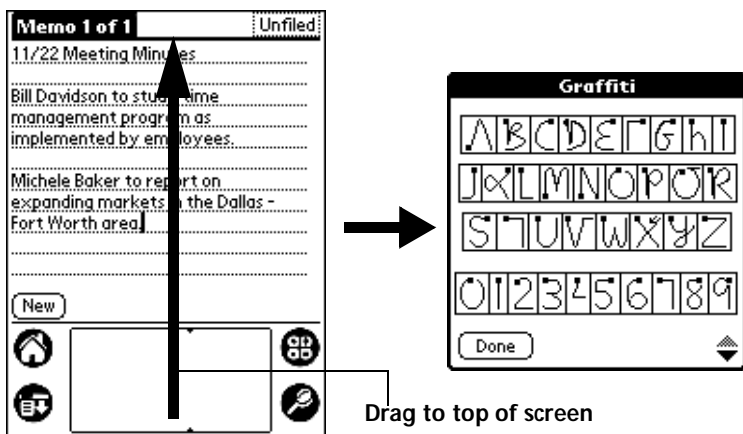

To change the Pen preferences:

1. Tap Pen.

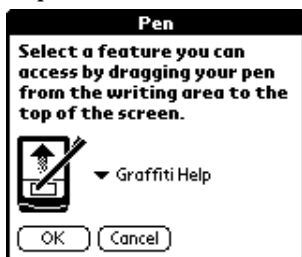

2. Tap the pick list and select one of the following settings for the full-screen pen stroke:

**Keyboard** Opens the onscreen keyboard for entering text characters.

**Graffiti Help** Opens a series of screens that show the complete Graffiti character set.

**Turn Off & Lock** Turns off and locks the organizer. You must assign a password to lock the organizer. When locked, you need to enter the password to use your organizer.

**Beam Data** Beams the current record to another Palm Computing® platform handheld.

**Brightness** Adjusts the brightness of the screen.

3. Tap OK.

## HotSync buttons preferences

The Buttons Preferences screen also enables you to associate different applications with the HotSync button on the cradle and the HotSync button on the optional modem. Any changes that you make in the HotSync Buttons dialog box become effective immediately; you do not have to change to a different screen or application.

To change the HotSync buttons preferences:

1. Tap HotSync.
2. Tap the pick list next to the button you want to assign.

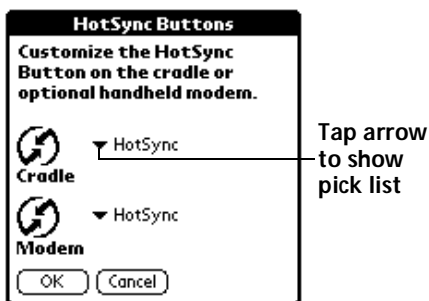

3. Tap the application that you want to assign to each button.

The default setting for each button is the HotSync setting, which means the cradle and optional modem perform their normal HotSync functions.

4. Tap OK.

## Digitizer preferences

The Digitizer Preferences screen opens the digitizer calibration screen. This is the same screen that appears when you start your organizer for the first time.

You can recalibrate your screen after a hard reset, or if your digitizer drifts.

## Formats preferences

Use the Formats Preferences screen to set the country default and the display format of the dates, times, and numbers on your organizer.



## Country default

The country default sets date, time, week start day, and number conventions based on geographic regions where you might use your organizer. For example, in the United Kingdom, time often is expressed using a 24-hour clock. In the United States, on the other hand, time is expressed using a 12-hour clock with an AM or PM suffix.

All your organizer applications use the Country default settings. You can, however, customize your own preferences as described in “Time, date, week start, and numbers formats” later in this chapter.

**To set the country default:**

1. Tap the country name pick list.

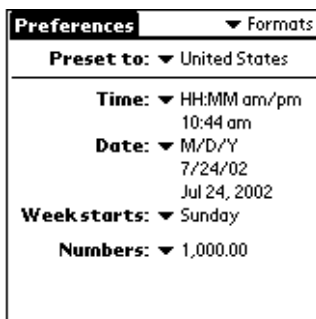

2. Tap the setting you want to use.

## Time, date, week start, and numbers formats

The Time setting defines the format for the time of day. The time format that you select appears in all applications on your organizer.

**To select the time, date, week start, and numbers format:**

1. Tap the Time pick list and select a format.
2. Tap the Date pick list and select a format.
3. Tap the Week starts pick list, and select whether you want the first day of the week to be Sunday or Monday.

**Note:** This setting controls the Day, Week, and Month views in Date Book and all other aspects of your organizer that display a calendar.

4. Tap the Numbers pick list, and select formats for the decimal point and thousands separator.

## General preferences

The General Preferences screen enables you to set the time, date, auto shutoff interval, and sounds for your organizer.

See Chapter 1 for information on setting the time and date.

### Auto-off delay

Your organizer has an automatic shutoff feature that turns off the power after a period of inactivity. This feature helps conserve battery power in case you forget to turn off your organizer.

If you find that your organizer shuts itself off before you finish reviewing the information on the screen, you should increase the time setting of the automatic shutoff feature.

**To set the Auto-off delay:**

1. Tap the Auto-off pick list.
2. Tap the setting you want to use for the automatic shutoff feature: 30 seconds, 1 minute, and 2 minutes.

### Cradle settings

You can choose to leave your organizer on when it is in the cradle during a HotSync operation, or when you are recharging the battery, so you can continue to view your data.

**Note:** To fully recharge the battery you need to turn your organizer off.

**To change the cradle setting:**

- Tap the Stay on in Cradle check box to leave your organizer on when it is in the cradle.

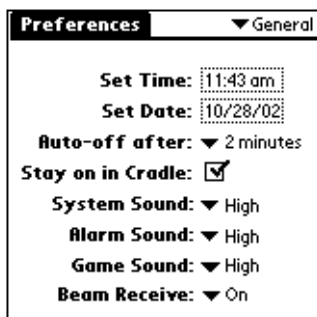

## System, alarm, and game sounds

Your organizer uses a variety of sounds. The System, Alarm, and Game Sound settings enable you to turn the sounds on or off, and to adjust the volume level.

**To set the system and alarm sounds:**

1. Tap the System Sound pick list and select the sound level.

**Note:** When you turn off the System Sounds, you also turn off the “chime” tones associated with the HotSync operation.

2. Tap the Alarm Sound pick list and select the sound level.
3. Tap the Game Sound pick list and select the sound level.

**Note:** The Game Sound setting works only with games that are programmed to respond to this setting. Older games typically do not respond to this setting.

## Beam Receive

You can choose to turn off the Beam Receive feature. This prohibits anyone from beaming information to your organizer. It also results in a slight saving of battery power.

**To change the Beam Receive setting:**

- Tap the Beam Receive pick list and select On or Off.

## Connection preferences

The Connection Preferences screen enables you to define the settings used to perform different types of HotSync operations. The screen displays a list of available configurations that are ready to be further defined; the list varies depending on the kind of software you've added to your organizer.

For example, a modem connection appears on the list. If you have this modem, you only need to specify the phone setup (and network connection — if required) to complete the configuration.

**Note:** You can purchase a modem for use with your organizer. See <http://www.palm.com>.

You can also create custom configurations. There are four possible kinds of connections.

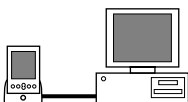

**Serial to PC:** A local HotSync connection: the direct serial connection between your organizer and your desktop computer. Your organizer is connected by its serial port to the cradle, and the cradle is attached by its cable to a serial (COM) port of your desktop computer.

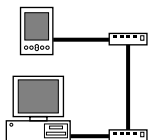

**Serial to Modem:** A connection between a modem attached to the serial port of your organizer and a modem that is part of your computer or laptop.



**IrCOMM to PC:** A connection between the IR port of your organizer and the infrared device of your computer or laptop.

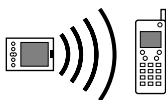

**IrCOMM to Modem:** A connection between the IR port of your organizer and a modem. The modem can be attached to a computer or some other device containing an IR port.

---

## Sample connection for remote IR HotSync operations

The following sample configuration would enable you to perform an IR HotSync operation by sending data through the IR port of a modem attached to a cell phone, which then dials a modem attached to your desktop computer, to synchronize with your Desktop application. For this example, you use the IrCOMM to Modem connection.

To create an IrCOMM to Modem connection:

1. Tap New.
2. Enter a name to identify this configuration.
3. Tap the Connection Method pick list and select IrCOMM to Modem.



4. Tap the Dialing pick list and select TouchTone or Rotary.
5. Tap the Volume pick list and select the speaker volume you want to use.
6. Tap Details.

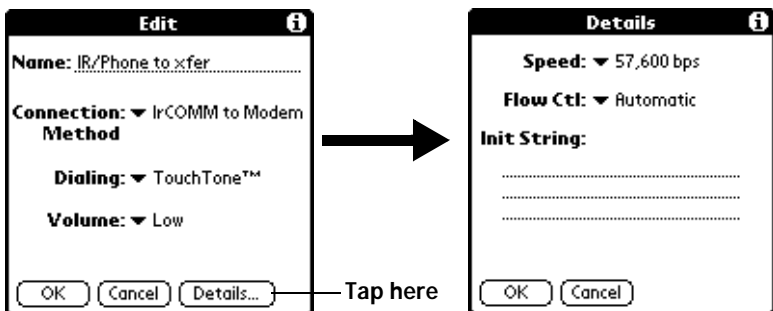

7. Enter the initialization string supplied by the documentation for the modem attached to your cell phone.
8. Tap OK, and then tap OK again to save the configuration.

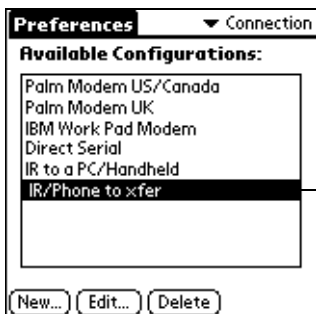

Your new configuration appears in the list of available configurations

After you create the configuration, you need to set up the HotSync Manager of your Desktop application and the HotSync application of your organizer to perform a modem HotSync operation.

## Network preferences and TCP/IP software

The Network Preferences settings enable you to use the TCP/IP software that is included in the organizer operating system. You can use the TCP/IP software to connect with Internet Service Providers (ISPs) or dial-in (remote access) servers. Because the TCP/IP software is a feature of the operating system, you configure all parameters relating to it from the Preferences application.

To use TCP/IP, you must create a configuration in Connection Preferences and then create Network Preferences settings.

**Note:** The Connection Preferences screen enables you to define several ways that your organizer can use the modem to communicate with remote devices. For example, you can communicate with your ISP server, or with your computer if you are away on travel. See “Connection preferences” earlier in this chapter for a complete explanation on how to create modem configurations.

After you configure both the Connection and Network Preferences, you can establish a PPP (Point-to-Point Protocol), SLIP (Serial Line Internet Protocol), or CSLIP (Compressed Serial Line Internet Protocol) connection with your ISP or dial-in server. You can do this either by using menu commands from the Network Preferences screen or by using a third-party application.

**Note:** TCP/IP provides the ability to connect to your ISP or dial-in server with applications that allow you to view the transmitted data. Visit the web site <http://www.palm.com> for information on third-party applications that take advantage of TCP/IP.

### Selecting a service

Use the Service setting to select the service template for your Internet Service Provider or a dial-in server. Service templates are a set of ISP and dial-in server configuration settings that you can create, save, and reuse.

To select a service:

1. Tap the Service pick list.

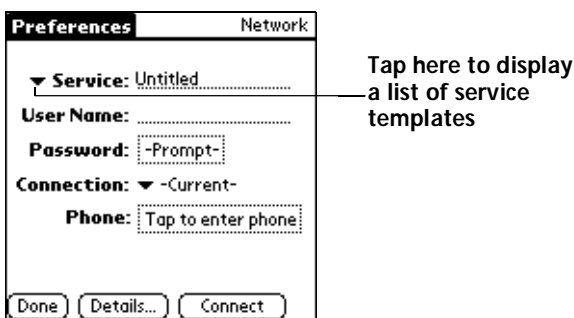

2. Tap the predefined service template you want to use.

## Entering a user name

The User Name setting identifies the name you use when you log into your Internet Service Provider or your dial-in server. Although this field can contain multiple lines of text, only two lines appear onscreen.

To enter a user name:

1. Tap the User Name field.
2. Enter your user name.

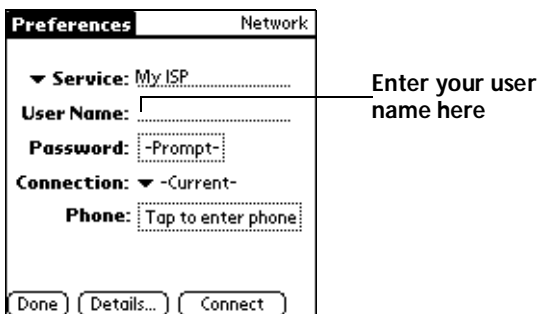

**Note:** Most dial-in servers do not accept spaces in the user name.



## Entering a password

The Password box identifies the password you use to log into your server or ISP. Your entry in this field determines whether your organizer prompts you to enter a password each time you log into your network:

- If you do not enter a password, your organizer displays the word “Prompt” in this field and asks you to enter a password during the login procedure.
- If you enter a password, your organizer displays the word “Assigned” in this field and does not prompt you to enter a password during the login procedure.

**Note:** If you are concerned about security, select the Prompt option and do not enter a password.

To enter a password:

1. Tap the Password field.
2. Enter the password you use to log into your server.

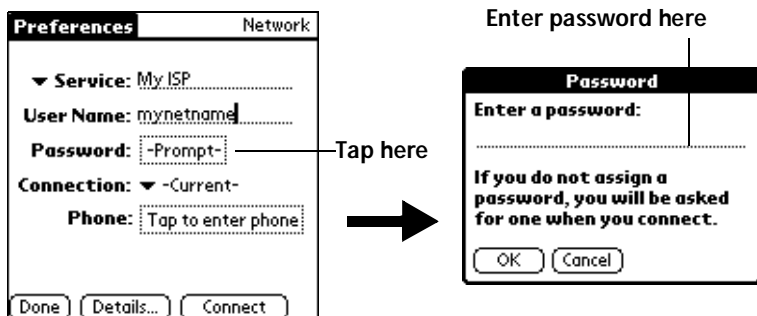

3. Tap OK.

**Note:** The Password field updates to display the word “Assigned.”

## Selecting a connection

Use the Connection setting to select the method you want to use to connect to your Internet Service Provider or a dial-in server. See “Connection preferences” earlier in this chapter for information about creating and configuring connection settings.

To select a connection:

1. Tap the Connection pick list.



Tap here to display a list of available connections

2. Tap the connection you want to use.

## Adding telephone settings

When you select the Phone field, your organizer opens a dialog box in which you define the telephone number you use to connect with your ISP or dial-in server. In addition, you can also define a prefix, disable Call Waiting, and give special instructions for using a calling card.

**Note:** The Phone Setup dialog box works correctly for AT&T and Sprint long-distance services. However, because MCI works differently, MCI customers need to put the calling card number in the Phone # field and the phone number in the Use calling card field.

To enter your server phone number:

1. Tap the Phone field.
2. Enter the phone number for your ISP or dial-in server.



Enter your ISP phone number here

3. If you need to enter a prefix or disable Call Waiting, skip to those procedures. Otherwise, tap OK.

## Entering a prefix

A prefix is a number that you dial before the telephone number to access an outside line. For example, many offices require that you dial “9” to dial a number outside the building.

To enter a prefix:

1. Tap the Dial Prefix check box to select it.



2. Enter the prefix.
3. Tap OK.

## Disabling Call Waiting

Call Waiting can cause your session to terminate if you receive a call while you are connected. If your telephone has Call Waiting, you need to disable this feature before logging into your ISP or dial-in server.

To disable Call Waiting:

1. Tap the Disable call waiting check box to select it.

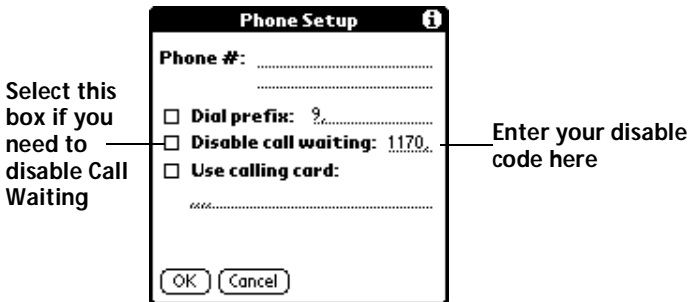

2. Enter the code to disable Call Waiting on the Disable call waiting line.

**Note:** Each telephone company assigns a code to disable Call Waiting. Contact your local telephone company for the code that is appropriate for you.

3. Tap OK.

### Using a calling card

The Use calling card field enables you to use your calling card when dialing your ISP or Intranet server. Keep in mind that there is usually a delay before you enter your calling card number. When you define your calling card number, you need to add commas at the beginning to compensate for this delay. Each comma delays transmission of your calling card number for two seconds.

To use a calling card:

1. Tap the Use calling card check box to select it.

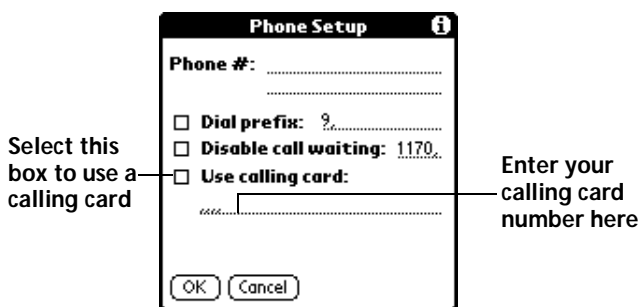

2. Enter your calling card number on the Use calling card line.

**Note:** It's a good idea to add at least three commas before your calling card number to compensate for the cue delay.

3. Tap OK.

### Connecting to your service

After you set your Connection and Network Preferences, establishing a connection to your Internet Service Provider (ISP) or your company's network (dial-in server) is easy.

**Note:** If you are connecting to an ISP, you need a third-party application, such as a web browser or news reader, to take advantage of this connection. For information about third-party applications that support TCP/IP, check the web site <http://www.palm.com>.

**To establish a connection:**

- Tap Connect to dial the current service and display the Service Connection Progress messages.

**Tip:** To see expanded Service Connection Progress messages, press the lower half of the Scroll button.

**To close a connection:**

- Tap Disconnect to terminate the connection between your organizer and your service.

## Creating additional service templates

You can create additional service templates from scratch or by duplicating existing templates and editing information. After you create a new or duplicate template, you can add and edit settings.

**To add a new service template:**

1. Tap the Menu icon .
2. Tap Service, and then tap New.

An Untitled service template is added to the Service pick list.

**To duplicate an existing service template:**

1. Tap the Service pick list.
2. Tap the predefined service template you want to duplicate.
3. Tap the Menu icon .
4. Tap Service, and then tap Duplicate.

A copy of the service template is added to the Service pick list.

## Adding detailed information to a service template

If you are using one of the predefined service templates, you probably only need to enter your user name and telephone number. If you are creating a new service template, you may need to provide additional information to your ISP or dial-in server. You use the Details dialog box to add additional information to a selected service template.

**To select a connection type:**

1. Tap the service field.
2. Tap Details.

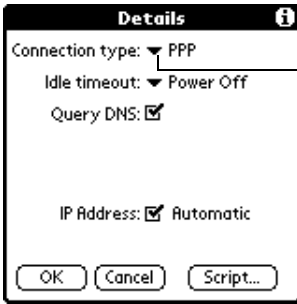

Select connection type

3. Tap the Connection type pick list and select one of the following connection types:

<b>PPP</b>	Point-to-Point protocol
<b>SLIP</b>	Serial Line Internet Protocol
<b>CSLIP</b>	Compressed Serial Line Internet Protocol

**Note:** If you are not sure, try PPP; if that doesn't work, ask your Internet Service Provider or your System Administrator for the correct connection type.

### Idle timeout

The Idle timeout setting defines how long your organizer waits before dropping the connection with your ISP or dial-in server when you switch out of a TCP/IP application.

#### To set the Idle timeout:

1. Tap the Idle timeout pick list and select one of the following options:

<b>Immediate</b>	Drops the connection to your ISP immediately when you switch to another application.
<b>1 minute</b>	Waits one minute for you to open another application before it drops the connection.
<b>2 minutes</b>	Waits two minutes.
<b>3 minutes</b>	Waits three minutes.

**Power Off** Keeps your PPP or SLIP connection until you turn off your organizer (or until it times out). This option works best with the modem.

2. Tap OK.

## Defining primary and secondary DNS

The Domain Naming System (DNS) is a mechanism in the Internet for translating the names of host computers into IP addresses. When you enter a DNS number (or IP address), you are identifying a specific server that handles the translation services.

Each IP address has four sections, separated by periods. In the Details dialog box, you enter each section separately. Each section of an IP address is made up of a number from 0 to 255; numbers are the only allowable characters in this field.

Ask your Internet Service Provider or System Administrator for the correct Primary or Secondary DNS IP numbers.

**Tip:** Many systems do not require that you enter a DNS. If you are not sure, leave the DNS field blank.

**To enter a primary and secondary DNS:**

1. Tap the Query DNS check box to deselect it.
2. Tap the space to the left of the first period in the Primary DNS field, and then enter the first section of the IP address.

**Note:** Each section must be a number from 0 to 255.

3. Repeat step 2 for the second, third, and last sections of the Primary DNS field.
4. Repeat steps 2 and 3 for the Secondary DNS number.
5. Tap OK.

## IP address

Everyone who logs on to the Internet needs to have a unique identifier (an IP address), whether permanent or temporary. Some networks dynamically assign a temporary IP address when clients log in. The IP Address field lets you identify whether your network provides automatic (dynamic) temporary IP addressing.

**Note:** If your IP address is permanently assigned, you need to get that information from your System Administrator. If you are not sure, select Automatic.

## To identify dynamic IP addressing:

- Tap the IP Address check box to select it.

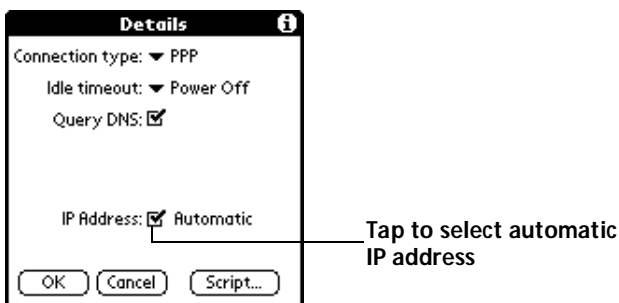

## To enter a permanent IP address:

1. Tap the IP Address check box to deselect it and display a permanent IP address field below the check box.
2. Tap the space to the left of the first period then enter the first section of the IP address.

**Note:** Each section must be a number from 0 to 255.

3. Tap and enter the remaining sections of the IP address.
4. Tap OK.

## Login scripts

A login script is a series of commands that automates logging in to a network server, for example, your corporate network or your Internet Service Provider (ISP). A login script is associated with a specific service template created in Network Preferences.

A login script is something that you are likely to receive from your IS System Administrator if your company has a system in which you log in to the corporate servers from your organizer using a modem or network connection. The script is generally prepared by the System Administrator and distributed to users who need it. It automates the events that must take place in order to establish a connection between your organizer and the corporate servers.

You can create login scripts in two ways:

- In a text editor on your desktop computer, in which you create a file with the extension PNC, which you then install on your organizer using the Install Tool (this method is not available to Macintosh users)



- In the Login Script dialog box on your organizer, accessed from the Details dialog box in Network Preferences

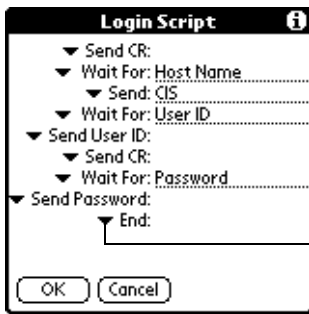

Tap here to see the list of available commands

**Note:** You can also use non-ASCII and literal characters in your login script. See Appendix D for more information.

## Creating a login script on your organizer

You can create login scripts by selecting commands from the Command pick list in the Login Script dialog. Some commands, such as Send, require you to supply additional information. Those commands have a parameter field so that you can add the necessary data.

**To create a login script:**

1. Tap Script.
2. Tap the End pick list.

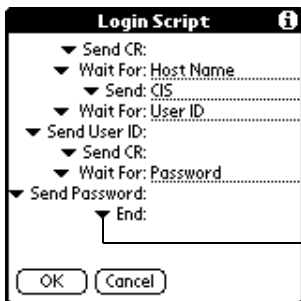

Tap here

3. Tap the command you want from the Command list. If the command requires additional information, a field appears to the right of it for you to enter the information. The following commands are available:

<b>Wait For</b>	Tells your organizer to wait for specific characters from the TCP/IP server before executing the next command.
<b>Wait For Prompt</b>	Detects a challenge-response prompt coming from the server and then displays the dynamically generated challenge value. You then enter the challenge value into your token card, which in turn generates a response value for you to enter on your organizer. This command takes two arguments, separated by a vertical bar ( ) on the input line.
<b>Send</b>	Transmits specific characters to the TCP/IP server to which you are connecting.
<b>Send CR</b>	Transmits a carriage return or LF character to the TCP/IP server to which you are connecting.
<b>Send User ID</b>	Transmits the User ID information entered in the User ID field of the Network Preferences screen.
<b>Send Password</b>	Transmits the password entered in the Password field of the Network Preferences screen. If you did not enter a password, this command prompts you to enter one. The Password command is usually followed by a Send CR command.
<b>Delay</b>	Tells your organizer to wait a specific number of seconds before executing the next command in the login script.
<b>Get IP</b>	Reads an IP address and uses it as the IP address for your organizer. This command is used with SLIP connections.
<b>Prompt</b>	Opens a dialog box and prompts you to enter text of some kind (for example, a password or a security code).
<b>End</b>	Identifies the last line in the login script.

4. Repeat steps 2 and 3 until the login script is complete.
5. Tap OK.

## Plug-in applications

You can create plug-in applications containing script commands that extend the functionality of the built-in script commands. A plug-in application is a standard PRC application that you install on your organizer just like any other application. After you install the plug-in application, you can use the new script commands in a login script.

Plug-in applications have the following characteristics:

- Written in C language
- Compiled into a device executable
- Called properly from a login script
- Able to return control to a login script after it terminates
- Created using a development environment that supports the Palm OS® software, such as Metrowerks CodeWarrior for Palm Computing Platform.

For additional information on creating plug-in applications, send e-mail to Palm Developer Support at [devsupp@palm.com](mailto:devsupp@palm.com).

## Deleting a service template

There is only one way to delete a service template: use the Delete command from the Service menu.

**To delete a service template:**

1. Tap the Service pick list.
2. Tap the service template you want to delete.
3. Tap the Menu icon .
4. Tap Service, and then tap Delete.
5. Tap OK.

## Network preferences menu commands

The Network Preferences screen includes menu commands to make it fast and easy to create and edit service templates. TCP/IP application menus are shown here for your reference. See “Using menus” in Chapter 1 for more information about choosing menu commands.

## Service menu

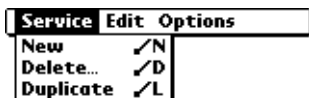

## Options menu

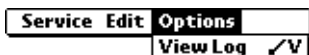

## TCP/IP troubleshooting

If you are having a problem establishing a network connection using TCP/IP, check this section and try the suggestions listed.

### Displaying expanded Service Connection Progress messages

It's helpful to identify at what point in the login procedure the connection fails. An easy way to do this is to display the expanded Service Connection Progress messages. Expanded Service Connection Progress messages describe the current stage of the login procedure. Press the lower half of the scroll button at any point during login to display these messages.

### Viewing the Network Log

If viewing the expanded Service Connection Progress messages does not give you enough information to find out why you cannot connect to your ISP or dial-in server, take a look at the Network Log. The Network Log lists all of the communication that occurs between your modem and your dial-in server during the login procedure. The information in the Network Log can help your ISP or your System Administrator pinpoint where the login procedure communication fails and why.

#### To view the Network Log:

1. Tap Options, and then tap View Log.
2. Tap the up and down arrows of the scroll bar to see the entire Network Log.
3. Tap Done.

### Adding a DNS number

If your ISP or dial-in server requires a DNS number and you did not enter that information in the Network Preferences screen, it will appear that you successfully logged into your network. When you try

to use an application or look up information, however, the connection fails. If this occurs, try adding a DNS number. Ask your ISP or your System Administrator for the correct Primary and Secondary DNS IP numbers.

## Owner preferences

The Owner Preferences screen enables you to record a name, company name, phone number, or any other information that you want to associate with your organizer.

If you use the Security application to turn off and lock your organizer with a password, information that you put in the Owner Preferences displays the next time you turn on your organizer. See Chapter 1 for more information.

To enter the Owner preferences:

- Enter the text that you want to associate with your organizer in the Owner Preferences screen. If you enter more text than can fit on one screen, a scroll bar automatically appears on the right side of the screen.

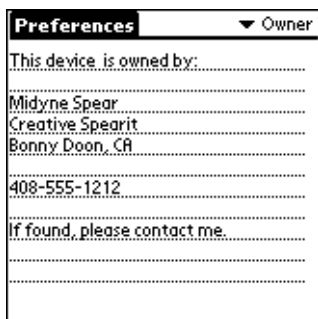

If you assign a password with the Security application, the information in the Owner Preferences screen cannot be changed. In this case, an Unlock button appears at the bottom of the screen.

To unlock the Owner Preferences screen:

1. Tap Unlock.
2. Enter the password that you defined in the Security application.
3. Tap OK.

# ShortCuts preferences

The ShortCuts Preferences screen enables you to define abbreviations for entering text with Graffiti strokes. This section describes how to create, edit, and delete a ShortCut. See Chapter 2 for more information on the use of ShortCuts.

## Creating a ShortCut

You can create a ShortCut for any words, letters, or numbers. All ShortCuts you create appear on the list in the ShortCut Preferences screen. All the ShortCuts are available in any of your organizer applications and are backed up on your computer when you perform a HotSync operation.

To create a ShortCut:

1. Tap New.
2. On the ShortCut name line, enter the letters you want to use to activate the ShortCut.

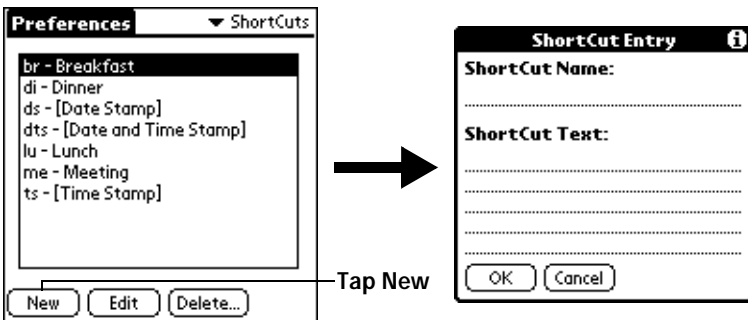

3. Tap the ShortCut Text area and enter the text that you want to appear when you write the ShortCut characters.

**Tip:** You may want to add a space (space character) after the last word in your ShortCut text. This way, a space automatically follows the ShortCut text.

4. Tap OK.

**Tip:** To use a ShortCut, draw the ShortCut stroke followed by the ShortCut characters. When you draw the ShortCut stroke, the ShortCut symbol appears at the insertion point to show that you are in ShortCut mode.

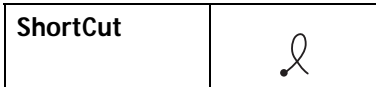

## Editing a ShortCut

After you create a ShortCut, you can modify it at any time.

**To edit a ShortCut:**

1. Tap the ShortCut you want to edit.
2. Tap Edit.
3. Make the changes you want and tap OK.

## Deleting a ShortCut

If you no longer need a ShortCut, you can delete it from the list of ShortCuts.

**To delete a ShortCut:**

1. Tap the ShortCut you want to delete.
2. Tap Delete.
3. Tap Yes.





## Appendix A

# Maintaining Your Organizer

This chapter provides information on the following:

- Proper care of your organizer
- Prolonging battery life
- Resetting your organizer

## Caring for your organizer

Your organizer is designed to be rugged and reliable and to provide years of trouble-free service. Please observe the following general tips when using your organizer:

- Take care not to scratch the screen of your organizer. Keep the screen clean. When working with your organizer, use the supplied stylus or plastic-tipped pens intended for use with a touch-sensitive screen. Never use an actual pen or pencil or other sharp object on the surface of the organizer screen.
- Your organizer is not waterproof and should not be exposed to rain or moisture. Under extreme conditions, water may enter the circuitry through the front panel buttons. In general, treat your organizer as you would a pocket calculator or other small electronic instrument.
- The touch-sensitive screen of your organizer contains a glass element. Take care not to drop your organizer or subject it to any strong impact. Do not carry your organizer in your back pocket: if you sit on it, the glass may break.
- Protect your organizer from temperature extremes. Do not leave your organizer on the dashboard of a car on a hot day, and keep it away from heaters and other heat sources.
- Do not store or use your organizer in any location that is extremely dusty, damp, or wet.
- Use a soft, damp cloth to clean your organizer. If the surface of the organizer screen becomes soiled, clean it with a soft cloth moistened with a diluted window-cleaning solution.

## Battery considerations

Please note the following considerations for the battery in your organizer:

- Under normal conditions, your organizer battery should remain charged by placing it in the cradle for just a few minutes each day. You can conserve battery life by reducing the brightness level on your organizer, and changing the Auto-off setting that automatically turns the organizer off after a period of inactivity. See “General preferences” in Chapter 7 for more information.

**Note:** To fully recharge the battery your organizer needs to be turned off while it is in the cradle.

- If the battery becomes low in the course of normal use, the battery icon indicates a low charge. If this happens, perform a HotSync® operation to back up your data; then leave your organizer in the cradle to recharge the unit. This helps prevent accidental data loss.
- If the battery drains to the point where your organizer does not operate, it stores your data safely for about a week. In this case, there is enough residual energy in the battery to store the data, but not enough to turn on your organizer. If your organizer does not turn on when you press the power button, you should recharge the unit immediately.
- If your battery drains and you have the unit in an uncharged state for an extended period of time, you can lose all of the stored data.
- There are no serviceable parts inside your organizer, so do not attempt to open the unit.
- If you ever dispose of your organizer, please dispose of it without damaging the environment. Take your organizer to your nearest environmental recycling center.
- The battery is designed to provide years of service under normal use. To prolong the battery’s useful life, charge it frequently even when it is not fully discharged.

## Resetting your organizer

Under normal circumstances, you will not have to use the reset button. On rare occasions, however, your organizer may no longer respond to buttons or the screen. In this case, you need to perform a reset to get your organizer running again.

### Performing a soft reset

A soft reset tells your organizer to stop what it's doing and start over again. All records and entries stored in your organizer are retained with a soft reset. After a soft reset, the Welcome screen appears, followed by the General Preferences screen (to set time and date).

To perform a soft reset:

- Use the reset tip tool, or the tip of an unfolded paper clip (or similar object *without* a sharp tip), to gently press the reset button inside the hole on the back panel of your organizer.

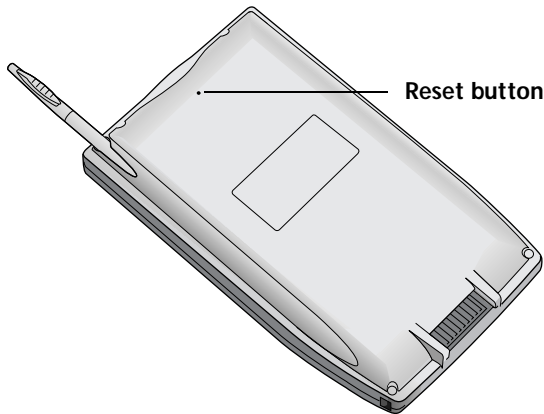

**Tip:** The metal and plastic stylus that comes with your organizer has a reset tip inside. To use it, unscrew the metal barrel from the stylus quill.

## Performing a hard reset

*With a hard reset, all records and entries stored in your organizer are erased. Never perform a hard reset unless a soft reset does not solve your problem.*

**Note:** You can restore any data previously synchronized with your computer during the next HotSync operation.

### To perform a hard reset:

1. Hold down the power button on the front panel of the organizer.
2. While holding down the power button, use the reset tip tool, or the tip of an unfolded paper clip (or similar object *without* a sharp tip) to gently press and release the reset button.
3. Wait for the Palm Computing® Platform logo to appear; then release the power button.
4. When a message appears on the organizer screen warning that you are about to erase all the data stored on your organizer, do one of the following:

Press the upper half of the scroll button on the front panel of the organizer to complete the hard reset and display the Digitizer screen.

Press any other button to perform a soft reset.

**Note:** With a hard reset, the current date and time are retained. Formats Preferences and other settings are restored to their factory default settings.

### To restore your data after a hard reset:

1. Click the HotSync icon ™ in the Windows system tray (bottom-right corner of the taskbar).

**Tip:** You can also click the HotSync command on the Palm Desktop software menu bar.

2. From the HotSync Manager menu, choose Custom.

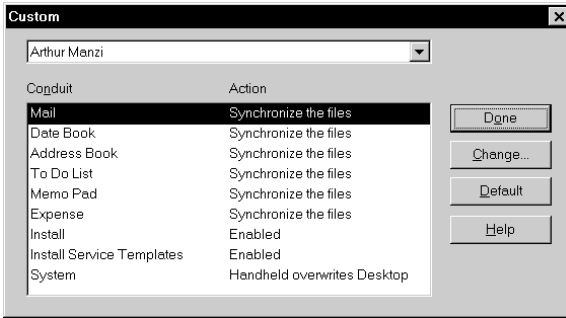

3. Select the appropriate user name from the list.
4. Select an application in the Conduit list.
5. Click Change.

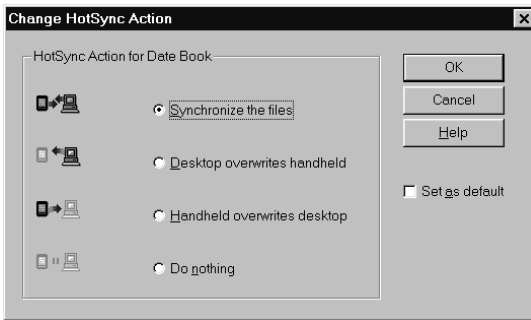

6. Select Desktop overwrites handheld.

**Note:** Changing the HotSync setting from the default affects only the *next* HotSync operation. Thereafter, the HotSync Actions revert to their default settings. To use a new setting on an ongoing basis, select the Set As Default box. Thereafter, whatever you selected as the default setting is used when you click the Default button in the Custom dialog.

7. Click OK.
8. Repeat steps 4 through 7 to change conduit settings for other applications.
9. Click Done to activate your settings.
10. Perform a HotSync operation.



## Appendix B

# Frequently Asked Questions

If you encounter a problem with your Palm IIIc™ organizer, do not call Technical Support until you have reviewed the following list of frequently asked questions, and you have also reviewed the following:

- The README file and HelpNotes located in the folder where you installed the Palm™ Desktop software on your computer (or on your installation CD or diskettes)
- The Palm Desktop online Help
- The “Palm Support Assistant” knowledgebase, accessible at <http://www.palm.com> under the Support section
- The most recent Palm IIIc organizer HelpNotes on your regional web site

If you are still having problems, contact Technical Support. For US and International telephone numbers, see the Technical Support card that comes with your organizer.

**Note:** Thousands of third-party add-on applications have been written for the Palm Computing® platform. Unfortunately, we are not able to support such a large number of third-party applications. *If you are having a problem with a third-party application, please contact the developer or publisher of that software.*

# Software installation problems

## Problem

When I install Palm Desktop software I get an error that a modem is attached to my serial port, but there is no modem attached.

I cannot install Palm Desktop software with Windows 95/98.

## Solution

Take your organizer out of the cradle and install Palm Desktop software again.

Try the following:

1. Disable any virus scanning software on your computer.
2. Press CTRL-ALT-DELETE and end all tasks except Systray and Explorer.
3. Make sure your computer has at least 20MB disk space.
4. Delete all temporary files.
5. Run ScanDisk on your computer.
6. Reinstall Palm Desktop software.



# Operating problems

Problem	Solution
I don't see anything on my organizer's screen.	Try each of these in turn: <ul style="list-style-type: none"><li>■ Press the brightness control button and adjust the brightness.</li><li>■ Recharge the unit. If your organizer still does not operate, try a soft reset. See "Resetting your organizer" in Appendix A.</li></ul>
I get a warning message telling me my organizer memory is full.	<ul style="list-style-type: none"><li>■ Purge records from Date Book and To Do List. This deletes To Do List items and past Date Book events from the memory of your organizer. See "Purging records" in Chapter 4. You may need to perform a HotSync® operation to recover the memory.</li><li>■ Delete unused memos and records. If necessary, you can save these records. See "Deleting records" in Chapter 4.</li><li>■ If you have installed additional applications on your organizer, remove them to recover memory. See "Removing applications" in Chapter 3.</li></ul>
My organizer keeps turning itself off.	Your organizer is designed to turn itself off after a period of inactivity. This period can be set at one, two, or three minutes. Check the Auto-off setting. See "General preferences" in Chapter 7.
My organizer is not making any sounds.	Check the System Sound setting. See "General preferences" in Chapter 7.
My organizer has frozen.	Perform a soft reset. See "Resetting your organizer" in Appendix A.

# Tapping and writing problems

## Problem

When I tap the buttons or screen icons, my organizer activates the wrong feature.

When I tap the Menu icon , nothing happens.

I can't get my organizer to recognize my handwriting.

## Solution

Calibrate the screen. See “Digitizer preferences” in Chapter 7.

Not all applications or screens have menus. Try changing to a different application.

- For your organizer to recognize handwriting input with the stylus, you need to use Graffiti® writing. See “Using Graffiti writing to enter data” in Chapter 2.
- Make the Graffiti character strokes in the Graffiti writing area, not on the display part of the screen.
- Write Graffiti strokes for letters in the left-hand side, and the strokes for numbers in the right-hand side of the Graffiti writing area.
- Make sure that Graffiti is not shifted into extended or punctuation modes. See “Using Graffiti writing to enter data” in Chapter 2.
- See “Graffiti tips” in Chapter 2 for tips on increasing your accuracy when you write Graffiti characters.

# Application problems

Problem	Solution
I tapped the Today button, but it does not show the correct date.	Your organizer is not set to the current date. Make sure the Set Date box in the General Preferences screen displays the current date. See “General preferences” in Chapter 7 for more information.
I know I entered some records, but they do not appear in the application.	<ul style="list-style-type: none"><li>■ Check the Categories pick list (upper-right corner). Choose All to display all of the records for the application.</li><li>■ Check Security and confirm that Private Records is set to Show private records.</li><li>■ In To Do List, tap Show and see if Show Only Due Items is selected.</li></ul>
I am having problems listing memos the way I want to see them.	<ul style="list-style-type: none"><li>■ If you cannot manually arrange the order of the memos in the list screen, check the Memo Preferences setting. Make sure that Sort by is set to Manual.</li><li>■ If you choose to view your memos alphabetically on Palm Desktop software and then perform a HotSync operation, the memos on your organizer still appear in the order defined in the Memo Preferences setting. In other words, the sort settings you use with Palm Desktop software <i>are not</i> transferred to your organizer.</li></ul>
I created an event in Date Book, but it doesn't appear in the Week View.	In the Week View, you cannot select overlapping events that have the same start time. If you have two or more events with the same start time, choose the Day View to see the overlapping events.
I entered the euro symbol, but after a HotSync operation it doesn't appear in my Palm Desktop software.	You must have fonts that include the euro symbol on your desktop computer. Check these web sites for additional information: <a href="http://www.microsoft.com/windows/euro.asp">http://www.microsoft.com/windows/euro.asp</a> <a href="http://til.info.apple.com/techinfo.nsf/artnum/n22222">http://til.info.apple.com/techinfo.nsf/artnum/n22222</a>

# HotSync problems

<b>Problem</b>	<b>Solution</b>
I cannot do a HotSync operation; what should I check to make sure I am doing it correctly?	<ul style="list-style-type: none"><li>■ Check the Windows system tray to make sure the HotSync Manager is running. If it is not, open Palm Desktop software.</li><li>■ Click the HotSync Manager, choose Setup and click the Local tab. Check that the Serial Port setting displays the correct COM port where your cradle is attached.</li><li>■ Make sure the cradle is connected securely.</li></ul>
I did a HotSync operation, but one of my applications did not synchronize.	<ul style="list-style-type: none"><li>■ Click the HotSync Manager and choose Custom. Check that the correct conduit is active.</li></ul>
I am using Outlook as my PIM, but I cannot do a HotSync operation.	<ul style="list-style-type: none"><li>■ Click the HotSync Manager and choose Custom. Check that the correct conduit is active.</li><li>■ Check that the correct conduit is installed. Reinstall the HotSync Manager and make sure the correct conduit is selected.</li></ul>
I cannot launch the HotSync Manager.	<ul style="list-style-type: none"><li>■ Make sure you are not running another program, such as America Online, CompuServe, or WinFax, that uses the serial port you selected in the Setup dialog box.</li><li>■ Backup the Palm Desktop software, uninstall it, then reinstall it.</li></ul>
My organizer appears to freeze when I place it near my computer.	Move your organizer away from the computer's infrared port.

I tried to do a local HotSync operation, but it did not complete successfully.

Try each of these in turn:

- Make sure HotSync Manager is running. If HotSync Manager is running, exit, and restart it.
- Make sure you selected Local from the HotSync Manager menu or the Palm Desktop software menu.
- Check the cable connection between the cradle and the serial port on your computer.
- Make sure you selected the correct serial port on the Local tab in the Setup dialog. It should be set to the port where you connected the cradle.
- Try a lower baud rate setting on the Local tab in the Setup dialog.
- Make sure you are not running another program, such as America Online, CompuServe, or WinFax, that uses the serial port you selected in the Setup dialog box.
- Read the HotSync Log for the user account for which you are performing a HotSync operation.
- Make sure your organizer is seated in the cradle correctly.
- Make sure the gold-plated connectors on the cradle and your organizer are clean. Use a pencil eraser to clean them.

I tried to do a modem HotSync operation, but it did not complete successfully.

Check the following on your computer:

- Make sure your computer is turned on and that it does not shut down automatically as part of an energy-saving feature.
- Make sure the modem connected to your computer is turned on and is connected to the outgoing phone line.
- Make sure Modem is checked in the HotSync Manager menu.
- Make sure the modem you are using with your organizer has an on-off switch. Your organizer cannot “wake up” a modem that has an auto-off feature.
- Make sure the modem is connected properly to a serial port on your computer and is connected to the incoming phone line.
- Confirm that the Setup String in the Setup dialog box configures your modem correctly. You may need to select a different Modem Type or enter a custom Setup String. Most modems have a Setup String that causes them to send initial connection sounds to a speaker. You can use these sounds to check the modem connection.
- Confirm that the Speed setting in the Setup dialog box works for your modem.
- If you have problems using the As Fast As Possible option or a specific speed, try using a slower speed.
- Make sure you are not running another program, such as WinFax, CompuServe, or America Online that uses the serial port you selected in the Setup dialog box.
- Make sure your modem resets before you try again. (Turn off your modem, wait a minute, then turn it back on.)

I tried to do a modem HotSync operation, but it did not complete successfully.  
(continued)

Check the following on your organizer:

- Confirm that the telephone cable is securely attached to your modem.
- Make sure the dialing instruction dials the correct phone number.
- If you need to dial an outside line prefix, make sure you selected the Dial Prefix option on your organizer and entered the correct code.
- If the telephone line you are using has Call Waiting, make sure you selected the Disable call waiting option under Modem Sync Phone Setup on your organizer and entered the correct code.
- Make sure the telephone line you are using is not noisy, which can interrupt communications.
- Check the batteries in your modem and replace them if necessary.

I can't perform an IR HotSync operation.

- Be sure the HotSync Manager is running and the Serial Port for local operations is set to the simulated port for infrared communication.
- On your organizer, be sure the HotSync application is set to Local, with the option IR to a PC/Handheld.
- Be sure the IR port of your organizer is aligned directly opposite to, and within a few inches of, the infrared device of your computer.
- IR HotSync operations do not work after you receive a low battery warning. Check the battery power of your organizer. Recharge the internal battery.

When I tap the HotSync button on the cradle, nothing happens on Palm Desktop software and my organizer times out.

- Perform a Local HotSync operation before you try to synchronize remotely via modem. Check Palm Desktop software HotSync Setup options to confirm that you have the correct settings for local HotSync operations.
- If you are experiencing intermittent success, try a lower speed setting on the Local tab in the Setup dialog box in the HotSync Manager.
- Close and restart HotSync Manager on your computer.
- Verify there are no COM port conflicts on your computer:
  1. From the Start menu, choose Settings, and then choose Control Panel.
  2. Double-click System.
  3. Click the Device Manager tab.
  4. Double-click Ports.
  5. Check each accessory is using a different port.
- Make a copy of your Palm folder. Uninstall, then reinstall Palm Desktop software.
- Turn on your organizer and tap the Applications icon. Tap the HotSync icon, then tap Local.

When I perform a HotSync operation, my information does not transfer to Palm Desktop software.

- If you have performed a HotSync operation successfully, but you cannot find the data from your organizer on Palm Desktop software, check to see you have the correct user name selected for viewing data.
- Click the HotSync Manager and choose Custom. Check that all conduits are set to synchronize files.



My organizer displays the message “Waiting for sender” when it’s near my computer’s infrared port.

- Your computer’s infrared port may be set to search automatically for the presence of other infrared devices. Do the following to turn off this option:
  1. In the Windows taskbar, click Start.
  2. Choose Settings, and then choose Control Panel.
  3. Double-click Infrared.
  4. Click the Options tab.
  5. Deselect the option Search for and provide status for devices in range.
  6. Click Apply and OK.
- If you are using Windows 98, move your organizer away from the computer’s infrared port.

I want to synchronize my computer with more than one organizer.

- If the computer running Palm Desktop software synchronizes with more than one organizer, each organizer must have a unique name. Assign a user name to your organizer the first time you perform a HotSync operation.
- Please be aware that synchronizing more than one organizer with the same user name causes unpredictable results and, potentially, loss of your personal information.

## Beaming problems

Problem	Solution
I cannot beam data to another Palm Computing platform handheld.	<ul style="list-style-type: none"><li>■ Confirm that your organizer and the other Palm organizer are between ten centimeters (approximately 4") and one meter (approximately 39") apart, and that the path between the two handhelds is clear of obstacles. Beaming distance to other Palm Computing platform handhelds may be different.</li><li>■ Move your organizer closer to the receiving handheld.</li></ul>
When someone beams data to my organizer, I get a message telling me it is out of memory.	<ul style="list-style-type: none"><li>■ Your organizer requires at least twice the amount of memory available as the data you are receiving. For example, if you are receiving a 30K application, you must have at least 60K free.</li><li>■ Perform a soft reset. See "Performing a soft reset" in Appendix A for more information.</li></ul>

## Recharging problems

Problem	Solution
When I place my Palm IIIc organizer in the cradle, it does not recharge.	<ul style="list-style-type: none"><li>■ Confirm that your organizer is well seated in the cradle.</li><li>■ Confirm that your recharger cable is properly connected to the back of the cradle's serial (COM) port connector that plugs into your computer.</li><li>■ Confirm that your recharger is plugged into an AC outlet that has power.</li><li>■ Confirm that you are using the cradle and AC adapter that came with the device.</li><li>■ Confirm your organizer is turned off or it will not fully charge.</li></ul>

# Password problems

## Problem

I forgot the password, and my organizer is not locked.

## Solution

You can use Security to delete the password, but your organizer deletes all entries marked as private. However, if you perform a HotSync operation *before* you delete the password: the HotSync process backs up all entries, whether or not they are marked private. Then, you can follow these steps to restore your private entries:

1. Use the Palm Desktop software and the cradle or infrared communication to synchronize your data.
2. Tap Forgotten Password in Security to remove the password and delete all private records.
3. Perform a HotSync operation to synchronize your data and restore the private records by transferring them from your computer to your organizer.

I forgot the password and my organizer is locked.

- If you assign a password and lock your organizer, you must perform a hard reset to continue using your organizer. See “Performing a hard reset” in Appendix A for more information.



# Technical support

If, after reviewing the sources listed at the beginning of this appendix, you cannot solve your problem, contact your regional technical support office by e-mail, phone, or fax.

Before requesting support, please experiment a bit to reproduce and isolate the problem. When you do contact support, please be ready to provide the following information:

- The name and version of the operating system you are using
- The actual error message or state you are experiencing
- The steps you take to reproduce the problem
- The version of organizer software you are using and available memory

## To find version and memory information:

1. Tap the Applications icon .
2. Tap the Menu icon .
3. Tap App, and then tap Info.

**Note:** Thousands of third-party add-on applications have been written for the Palm Computing platform. Unfortunately, we are not able to support such a large number of third-party applications. *If you are having a problem with a third-party application, please contact the developer or publisher of that software.*

4. Tap Version to see version numbers, and tap Size to see the amount of free memory in kilobytes.

## Appendix C

# Creating a Custom Expense Report

This section explains how to modify existing Expense application templates and how to create your own custom expense report templates for use with the Expense application.

**Note:** This section assumes that you are familiar with Microsoft Excel or a similar spreadsheet application. If you are not familiar with Microsoft Excel, consult your company's Information Services department or another experienced user.

## About mapping tables

Before creating or modifying an Expense template, it's important to understand the function of the Palm™ Desktop software Expense application. In simple terms, the Expense application is designed to move Expense data from your organizer into a Microsoft Excel spreadsheet. Each Expense item stored in your organizer represents a group of related data. You can associate the following data with an expense item:

- Category
- Date
- Expense Type
- Amount
- Payment Method
- Payment Currency
- Vendor
- City
- Attendees
- Note

When you perform a HotSync® operation between your organizer and Palm Desktop software on your computer, the Expense data is stored on your computer (in a file named Expense.txt). When you open the Expense application in Palm Desktop software, an Excel macro starts, and populates an expense template with your data based on the rules specified in a spreadsheet file named Mappable.xls.

The Mappable.xls file is an editable spreadsheet that functions as a "mapping table." The function of the mapping table is to guide the Excel macro in extracting the Expense data. The mapping table tells the Excel macro how large the spreadsheet is and provides the data-cell layout of the Excel template used for the Expense Report.

## Customizing existing sample templates

Four sample Expense Report templates come with Palm Desktop software. These templates are stored in the Template folder (which is in the same folder as the Palm Desktop software application).

If the layout of one (or more) of these templates is appropriate for your reporting needs, you can easily customize the templates with your company name and other information.

### To customize a sample Expense Report template:

1. Make a backup copy of the contents of the Template folder.

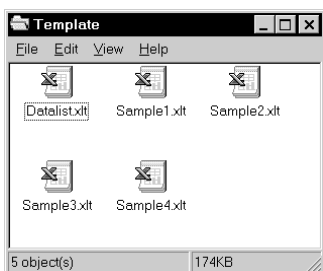

2. Double-click the name of the sample template you want to modify to open it in Microsoft Excel.
3. Make any changes that you want to the names (or other information) in the sample template.

**Important:** *Do not* insert rows or columns in the sample template. Doing so changes the way your Expense data maps to the template and causes errors. If you want to move the cells to a different location or add or delete rows or columns, you have to make changes to the Mappable.xls file.

**Note:** You can insert your own company logo without changing the Mappable.xls file. If you change the file name, however, you need to make a corresponding change in the Mappable.xls file.

You can also rename cells without changing the Mappable.xls file, provided that the expense type corresponds to your organizer data. For example, you can change "Snack" to "Munchies," and then all items entered on your organizer as "Snack" map to the cell(s) labeled "Munchies."

4. From the File menu, choose Save As.
5. Click the Save as type drop-down list and choose Template (\*.xlt).
6. Navigate to the Template folder (in the Palm Desktop software directory).

**Note:** If you *do not* need to change the Mappable.xls file, save the template file with its *original file name* (e.g., Sample2.xlt).

If you *do* need to change the Mappable.xls file, give your modified template a unique name. Be sure to use the .xlt file suffix, which defines the file as a Microsoft Excel template.

7. Click Save to save your modified template and make it available for future use.

**Note:** If you need to modify the Mappable.xls file, you must do this before you can use the modified template with your Expense data. To modify the Mappable.xls file for your new template, see “Programming the mapping table” later in this appendix. *Read all of the sections of this appendix before making changes to the Mappable.xls file.*

## Determining the layout of the Expense Report

This section describes the layout considerations for the Expense Report and explains the terms used for creating the report.

### Labels

There are two kinds of labels that you need to define for your report: day/date and expense type. Each kind of label can be either Fixed or Variable. A Fixed label means that the label *always* appears as a header at the beginning of a row or column. If a label is not Fixed, it is variable.

For example, a list table of expenses could have variable labels in the rows for day/date, and variable labels in the columns for expense type. In this case, neither day/date or expense type information would be “fixed” (as a header). Instead, the date and expense type information would be filled into the cells of the spreadsheet as appropriate.

Examples of both Fixed and Variable labels appear in the sample expense templates.





# Analyzing your custom Expense Report

If you already have a custom Excel expense report, you can use it with a modified mapping table. However, before you can create a Mappable.xls file that corresponds to your custom Expense Report, you must first analyze the characteristics of your report.

**Perform the following before you begin a custom mapping table:**

Print a copy of your custom expense report. Activate the Row and Column Headings option in the Sheet settings of the Page Setup command. This enables you to quickly determine the size of the Section(s), as well as the numbers for the start rows and columns.

On the printed copy, identify the data Sections. A Section is an area of data with common row and column formatting. A yellow highlighter marking pen can make it easy to see the Sections as you work with programming the mapping table. Your custom Expense Report can contain any number of Sections, and the same data can be repeated in any Section.

On the printed copy, identify the type of Labels that apply to each Section. Each Section can have only one kind of Fixed or Variable Label for rows. Likewise, each Section can have only one kind of Fixed or Variable Label for columns.

Place a copy of your custom Expense Report in the Template folder (in the Palm Desktop software directory). Change the file name so it has the file extension .xlt (which defines it as a Microsoft Excel template). Make a note of the exact file name so it can be defined in the mapping table file.

# Programming the mapping table

Once you have analyzed the components of your custom Expense Report, you can program the mapping table to fill the report with data from the organizer.

## To program a new custom mapping table:

1. Open a copy of the Maptable.xls file in Microsoft Excel.

**Note:** This file is located in the same folder as the Palm Desktop software application. *Make a backup copy of this file before you make your modifications.*

2. Mapping a new template. Scroll to where you find the name of the original template that you chose for your modifications. The name of the template will appear in column B of the Maptable.xls file, next to the cell highlighted in green that reads "Template Name:". If you did not modify an existing template, move to any table in the Maptable.xls file.
3. Select all the rows associated with the template name. To select the rows, click and drag on the row numbers (left side), so they appear highlighted.

	1	2	3	4	5
5	Template Name:	SAMPLE1.XLT			
6		ROW			
7		Fixed Label		Variable Label by	
8		Day/Date	Expense Type	Day/Date	Expense Type
9	Section1			X	
10					
11					
12					
13	Template Name:	SAMPLE2.XLT			
14		ROW			
15		Fixed Label		Variable Label by	
16		Day/Date	Expense Type	Day/Date	Expense Type
17	Main		X		
18	Business&Entertainment			X	
19					
20					
21					
22	Template Name:	SAMPLE3.XLT			
23		ROW			
24		Fixed Label		Variable Label by	
25		Day/Date	Expense Type	Day/Date	Expense Type
26	Main (PREPAID)		X		
27	Main		X		

All rows related to template are selected

4. From the Edit menu, choose Copy.

5. Scroll down to a blank area of the Mappable.xls file (below the rows used for Sample4.xlt), and click on a row number to select a blank row.
6. From the Edit menu, choose Paste. A copy of the rows you selected in step 3 is pasted into the Mappable.xls file.
7. Name the table. In the cell immediately to the right of the cell entitled Template Name, enter the *exact* file name of your custom Expense Report template.
8. Define the number of Sections. Each row in a table defines how your organizer data will be placed in a Section of your custom Expense Report. Note that the prepaid portion of a section has its own row and counts as a separate section for map table purposes, *even though it is not a separate section in your template.*

22	Template Name:	SAMPLE3.XLT	
23			ROW
24		Fixed Label	
25		Day/Date	Expense Type
26	Main (PREPAID)		X
27	Main		X
28	Business Meals & Entertainment		
29	Mileage Log		

Table with four sections

You may add or delete rows as necessary so that the total number of rows corresponds to the number of Sections in your custom Expense Report. To clear all of the existing settings in a row, click to select the row and press Ctrl+Delete. Name each row to correspond to a Section of your custom Expense Report.

9. Determine the Label settings. The orientation of the data fields (Row, Column) appears in the yellow section of the table.

SAMPLE1.XLT		ROW				COLUMN			
Fixed Label		Variable Label by		Fixed Label		Variable Label by			
Day/Date	Expense Type	Day/Date	Expense Type	Day/Date	Expense Type	Day/Date	Expense Type		
		X					X		

Determine whether the **Rows** will contain expense or date information, and place an “x” in the appropriate cell. When you do this, you also define whether the label is Fixed or Variable. You can place only one “x” in the Row section (columns 2–5).

Determine whether the **Columns** will contain expense or date information, and place an “x” in the appropriate cell. When you do this, you also define whether the label is Fixed or Variable. You can place only one “x” in the Column section (columns 6–9).

10. Define the dimensions of the Section. The dimensions of the Section appear in the green columns (10–13).

# of Rows	# of Columns	Start Row	Start Column
36		12	1

**# of Rows** Represents the total number of rows in the Section, excluding any header or total rows. In other words, this includes only the number of rows in the Section where your organizer data will be placed.

**# of Columns** Represents the total number of columns in the Section, excluding any header or total columns. In other words, this includes only the number of columns in the Section where your organizer data will be placed.

**Start Row** Is the number of the first row of the Section that will be filled with your organizer data.

**Start Column** Is the number of the first column of the Section that will be filled with your organizer data.

11. Define the Dates and Intervals. The dates and intervals between dates appears in the light blue columns (14–17).

Date	Intervals		
Date	Dates	Start day	Day
1	0		

In the **Date** cell, enter the row or column number where all the date information will be placed.

In the **Dates** cell, enter the number of blank columns (or rows) separating the date fields. If there are no blank columns (or rows) between date entries, leave this number set to zero.

In the **Start Day** cell, enter the day of the week that starts the expense reporting period. Enter a three-character abbreviation for the day (e.g., Sun, Mon, Tue).

In the **Day** cell, enter the row or column number where all the day information will be placed. If the dates are in a row, enter the row number. If the dates are in a column, enter the column number.

12. Define whether the Section is in list format. This setting appears in the light purple columns (18–19).

Listing Format	Expense Type
YES	8

If the Section will present the data in a list format, enter the word “yes”. Otherwise, enter the word “no”. The following diagram shows data presented in a list format:

6	Date	Category	Type	Amount	Country	Payment Type
7						
8						
9						
10						
11						

**Only if your section is in list format:** In the Expense Type cell, enter the number of the row or column where the expense description will be placed. Expense amounts can be entered in several different columns or rows if required by your template. *Expense type labels* must all appear in the same column.

13. Enter the row or column numbers for the expense types that appear in the Section. These settings appear in the aqua columns (20–48).

Expense Types					
Airfare	Breakfast	Bus	Business Meals	Car Rental	Dinner
4	4	4	4	4	4

For these settings, simply enter the row or column number for the expense types that you want to appear in the Section. Note that you can use a row or column number more than once. An example of this would be meals that encompass breakfast, lunch, dinner, and snacks. In the previous example, all expense items would be populated into row/column 4 of the custom Expense Report.

14. Complete the table. All of the remaining columns (49–57) in the table are used to define the column or row number that corresponds to the description.
15. Mark a Section for prepaid expenses (yellow column). If a row in the map table is for prepaid (company paid) expenses, type a “yes” in the cell on that Section’s row. Type “no” in all the cells of this column that do not pertain to prepaid expenses.

57
PrePaid
NO
YES
NO

16. Repeat steps 9 through 15 for each Section that you have defined for your custom Expense Report.
17. Map Expense Report Options dialog (magenta section). The Expense Report Options dialog has five fields where you can fill in data for the header on your expense report. Use this section to specify the row and column on your template where this information will be mapped.

Employee Name		Department	
Header1Row	Header1Col	Header2Row	Header2Col
2	5	2	9

Because header data is not related to any particular Section, you have to fill in only one row. If the item does not appear on your template, leave these cells blank.

## Using applications other than Microsoft Excel

You can use applications other than Microsoft Excel (such as Lotus 1-2-3 or Quattro Pro) to open and manipulate the Expense data on your computer. The data file is named "Expense.txt," and is stored in the Expense folder, within the folder containing the organizer user data.

Expense data in the Expense.txt file is in tab-delimited format.

## Expense file details

The Expense.txt file contains four groups of data. It will be easier to see these four distinct groups of data if you open the file with a spreadsheet application.

- Trips**                      Shows the number of Expense application categories, and lists each one followed by an "end" statement.
- Currency**                Shows how many currencies were used for the Expense data, and lists the countries that correspond to that currency.
- Trip**                        Shows the number of expenses by category, and lists the expenses for each category.
- Expenses**                Shows the total number of expenses, and lists them chronologically.

## Appendix D

# Non-ASCII Characters for Login Scripts

The following information enables you to create custom login scripts that require non-ASCII characters. It is provided for advanced users who understand the use and requirements of such characters in a custom login script.

## Use of ^char

You may use the caret ( ^ ) to transmit ASCII command characters. If you send ^*char*, and the ASCII value of *char* is between @ and \_, then the character is automatically translated to a single-byte value between 0 and 31.

For example, ^M is converted to a carriage return. If *char* is a value between a and z, then the character sequence is translated to a single-byte value between 1 and 26. If *char* is any other value, then the character sequence is not subject to any special processing.

For example, the string “Joe^M” transmits Joe, followed by a carriage return.

## Carriage return and line feed

You may include carriage return and line feed commands as part of the login script, when entered in the following format:

<cr>	Sends or receives a carriage return
<lf>	Sends or receives a line feed

For example, the string “waitfor Joe<cr><lf>” waits to receive Joe followed by a carriage return and line feed from the remote computer before executing the next command in the script.

## Literal characters

The backslash ( \ ) character defines that the *next character* is transmitted as a literal character, and is not subject to any special processing ordinarily associated with that character.

### Examples:

- \^ Includes a caret as part of the string
- \< Includes a < as part of the string
- \\ Includes a backslash as part of the string



# Product Regulatory Information

## FCC Statement

This device complies with part 15 of the FCC rules. Operation is subject to the following two conditions: (1) This device may not cause harmful interference, and (2) this device must accept any interference received, including interference that may cause undesired operation.

**Note:** This equipment has been tested and found to comply with the limits for a Class B digital device, pursuant to Part 15 of the FCC rules. These limits are designed to provide reasonable protection against harmful interference in a residential installation. This equipment generates, uses, and can radiate radio frequency energy and, if not installed and used in accordance with the instructions, may cause harmful interference to radio communications. However, there is no guarantee that interference will not occur in a particular installation. If this equipment does cause harmful interference to radio or television reception, which can be determined by turning the equipment off and on, the user is encouraged to try to correct the interference by one or more of the following measures:

- Reorient or relocate the receiving antenna.
- Increase the separation between the equipment and receiver.
- Connect the equipment into an outlet on a circuit different from that to which the receiver is connected.
- Consult the dealer or an experienced radio/TV technician for help.

The use of shielded I/O cables is required when connecting this equipment to any and all optional peripheral or host devices. Failure to do so may violate FCC rules.

**Caution:** Changes or modifications not covered in this manual must be approved in writing by the manufacturer's Regulatory Engineering Department. Changes or modifications made without written approval may void the user's authority to operate this equipment.

### Responsible Party:

Palm Computing, Inc.  
5400 Bayfront Plaza  
PO Box 58007  
Santa Clara, California 95052-8007  
United States of America  
(408) 326-5000

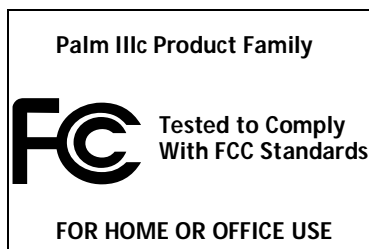

## Canadian ICES-003 Statement

This Class B digital apparatus meets all requirements of the Canadian Interference-Causing Equipment Regulations.

Cet appareil numérique de la classe B respecte toutes les exigences du Règlement sur le matériel brouilleur du Canada.



## CE Compliance Statement

This product was tested by Palm Computing, Inc. and found to comply with all the requirements of the EMC Directive 89/336/EEC as amended.



This is a Class B product based on the standard of the Voluntary Control Council for Interference from Information Technology Equipment (VCCI). If this is used near a radio or television receiver in a domestic environment, it may cause radio interference. Install and use the equipment according to the instruction manual.

この装置は、情報処理装置等電波障害自主規制協議会（VCCI）の基準に基づくクラスB情報技術装置です。この装置は、家庭環境で使用することを目的としていますが、この装置がラジオやテレビジョン受信機に近接して使用されると、受信障害を引き起こすことがあります。

取扱説明書に従って正しい取り扱いをして下さい。

## Battery Warning

Do not mutilate, puncture, or dispose of batteries in fire. The batteries can burst or explode, releasing hazardous chemicals. Discard used batteries according to the manufacturer's instructions and in accordance with your local regulations.

### Warning

Eksplisionsfara vid felaktigt batteribyte. Använd samma batterityp eller en ekvivalent typ som rekommenderas av apparattillverkaren. Kassera använt batteri enligt fabrikan- tens instruktion.

### Advarsel!

Lithiumbatteri—Eksplisionsfare ved fejlagtig håndtering. Udskiftning må kun ske med batteri af samme fabrikat og type. Levér det brugte batteri tilbage tilleverandøren.

## Varoitus

Paristo voi räjähtää, jos se on virheellisesti asennettu. Vaihda paristo ainoastaan valmistajan suosittelemaan tyyppiin. Hävitä käytetty paristo valmistajan ohjeiden mukaisesti.

## Advarsel

Ekspløsjonsfare ved feilaktig skifte av batteri. Benytt samme batteritype eller en tilsvarende type anbefalt av apparatfabrikanten. Brukte batterier kasseres i henhold til fabrikkantens instruksjoner.

## Waarschuwing!

Bij dit produkt zijn batterijen geleverd. Wanneer deze leeg zijn, moet u ze niet weggooiden maar inleveren als KCA.

## Uwaga

Nie kroić lub przekłuwać baterii, ani nie wrzucać ich do ognia. Mogą się rozerwać lub wybuchnąć wydzielając trujące środki chemiczne. Zużytych baterii należy pozbywać się w sposób opisany przez producenta i zgodnie z miejscowymi przepisami.

Nowe baterie powinny być tego samego lub analogicznego typu, co baterie zalecane w instrukcji obsługi kieszonkowego komputera Philips. Regeneracyjne baterie litowe mogą wybuchnąć jeżeli nie są odpowiednio umieszczone w komputerze.

אזהרה

יש סכנת התפוצצות אם מחליפים את הסוללה בצורה לא נכונה.  
יש להחליף את הסוללה בסוללה זהה או דומה, בהתאם להמלצת היצרן.  
יש להשליך סוללות משומשות בהתאם להוראות היצרן



# Index

## A

- ABA (Address Book archive file) 37
- AC adapter for recharging battery 11
- Accented characters
  - Graffiti writing 34
  - onscreen keyboard 36
- Add-on applications 42–45
- Address Book
  - \*If Found Call\* entry 89
  - adding custom fields 92
  - archive files (.aba) 37
  - business card for beaming 139
  - categorizing records 61
  - conduit for synchronizing 146
  - creating records 55, 88–89
  - deleting records 57
  - displaying category 92
  - displaying data in the Address list 91
  - finding records 65
  - fonts 73
  - menus 91
  - notes for records 72
  - opening 51
  - overview 51
  - pressing button to beam information 141
  - private records 71
  - sorting records 69
- Agenda (Date Book view) 85
- Alarm
  - preset 87
  - setting 78
  - sound 87, 171, 201
  - for untimed events 79
- Alphabet
  - Graffiti writing 30
  - onscreen keyboard 16, 21
- Application buttons 7, 17, 50, 51, 52, 53, 141, 166
- Applications
  - Address Book 51
  - beaming 139–140
  - Calculator 53
  - categories 39–40
  - Date Book 50
  - Expense 54
  - font style 73
  - installing 42–44
  - Launcher 17–18, 39–41
  - Memo Pad 53
  - opening 18
  - plug-in 187
  - preferences for 41
  - removing 45
  - security 46
  - size in kilobytes 212
  - To Do List 52
  - version of 212
  - viewing as icons 40
  - viewing as list 40
  - See also* Add-on applications
- Archive files
  - importing data from 37
  - for main applications 37
  - saving deleted records 57
  - saving purged records 58
- Automatic fill, in Expense 113
- Auto-off delay 170
- Autotext. *See* Graffiti ShortCuts

## B

- Battery
  - conserving power 170
  - gauge 18
  - life and use 194
  - recharging 11–12
  - recycling 194
  - warning 226–??
- BCC (blind carbon copy) 124
- Beaming
  - information 139–141
  - location of IR port 9
  - pen stroke to activate 167
  - problems with 210
  - See also* Infrared
- Bold font for text 73
- Brightness 6, 7, 167, 194, 201

Business card for beaming 139

Buttons preferences 166

## C

Calculator

buttons explained 101

memory 101

opening 54

overview 53

recent calculations 53, 101

Calibration 15, 168, 202

Call Waiting, disabling 156, 179

Calling card, using in phone settings  
156, 180

Capital letters (Graffiti writing) 31

Caring for the organizer 193

Categories

application 39–40

assigning records to 61–62

beaming 139–140

creating 63

default 61

displaying 62, 92, 203

folders for e-mail 130

merging 64

renaming 64

using in Applications Launcher  
40

cc:Mail 116

Chain calculations 101

Characters, Graffiti 27

Check boxes 16

Clearing Calculator entries 101

COM port 149, 150

*See also* Serial port

Combining categories 64

Comma delimited files, importing  
data from 37

Command

buttons 16

equivalents (Graffiti writing) 19

toolbar 20

Compressing Day view 87

Computer keyboard, entering data  
with 23

Conduits

for connecting to PIMs 14

for modem HotSync operations  
156

for synchronizing applications  
204, 146–147, 197

Confirming e-mail 126

Conflicting events 84

Connecting

service templates 181

to server or ISP 180

Connection

preferences 175

selecting for network 177

Continuous events

deleting from Date Book 57

scheduling 79

Copying text 56

Country default setting 169

Cradle

connecting to computer 10

for local HotSync operations 59,  
152

viewing data from 170

Creating

Address Book entries 88–89

categories 39–40, 63

currency symbols 107

custom fields in Address Book  
92

Date Book events 74

e-mail 119–121

Expense items 103

expense reports in Excel 109–112

memos 98

notes for records 72

records 55

To Do List items 93

Currency

default 106

defining 107

for Expense items 105, 106

Current date 25, 203

Current time 18

setting 25

Custom

currencies and symbols 107

expense reports 213–222

fields in Address Book 92  
Customizing. *See* Preferences  
Cutting text 56  
Cycling through views 50, 51, 52, 53

## D

Data entry. *See* Entering data

Date Book

- adding Address Book data to records 67
- Agenda view 85
- alarm 78
- archive files (.dba) 37
- changing event time 78
- changing event to untimed 77
- conduit for synchronizing 146
- conflicting events 84
- continuous events 79–81
- creating records 55, 74–78
- Day view 82
- deleting records 57
- display options 86
- end time for Day view 87
- fonts 73
- menus 86
- Month view 84
- notes for records 72
- opening 50
- overview 50
- private records 71
- purging records 58
- repeating events 57, 79–81
- scheduling events 74–78
- selecting dates 76
- start time for Day view 87
- Sunday or Monday to start week 169
- switching views 82
- untimed events 74, 77
- Week view 82, 169, 203

Dates

- Expense item 104
- setting current 25, 203
- showing in Mail list 131
- To Do List record due 95

Day (Date Book view) 74, 87

DBA (Date Book archive file) 37

Decimal point 169

Default

- categories 61
- currency in Expense 106
- settings. *See* Preferences

Deleted

- data, saving in archive files 57
- e-mail, recovering 129

Deleting

- applications 42, 45
- Desktop software 45
- e-mail 129
- Graffiti characters 29
- passwords 47
- records 57
- service templates 187
- text 56
- See also* Purging records

Delivering e-mail 123, 126

Desktop E-Mail application

- applications supported 116
- managing 115–138
- support of Mail features 123

Desktop software 12–13

- configuring mail 116–118
- displaying euro 109
- for entering data 23
- linking to external files 161
- removing 45
- saving deleted data to an archive file 57
- system requirements 4
- upgrading 4
- See also* PIM

Digitizer 15, 168, 202

DNS (Domain Naming System) 183

Double-booked events 84

Draft e-mail 127

Dragging

- memos into other applications 53
- stylus to activate features 167
- using the stylus 15

Driver for infrared communication on Windows 95 149

## E

### Editing

- records 55–57
- unsent e-mail 126

### E-mail addresses

- in Address Book 89, 91
- looking up 122–123

### E-mail items. *See* Mail

### Entering data 21–24

- importing from other
  - applications 37–38
  - problems with 202
  - using Graffiti writing 27–36
  - using the computer keyboard 37
  - using the onscreen keyboard 36

### Entries. *See* Address Book

### Eudora 116

### Euro

- displaying on desktop computer 109
- in Expense 106
- in Graffiti writing 33
- in onscreen keyboard 22
- printing 109
- problems with 203

### Events. *See* Date Book

### Excel, transferring Expense data to 108–112

### Exchange 116

### Exchanging data. *See* HotSync

### Exclamation marks in To Do List 97

### Expense

- adding Address Book data to records 68
- categorizing records 61
- conduit for synchronizing 146
- creating records 55, 103
- currency 105, 106
- date of item 104
- defining new currency 107
- deleting records 57, 81
- menus 112
- notes for records 72
- opening 54
- overview 54
- purging records 58
- receipt details 104

- reports in Excel 109–112, 213–222

- sorting records 69

- templates for reports 111

- type 105, 113

- vendor 105

### External keyboard 24

## F

### FCC Statement 225

### Files, linking to external 161

### Filing e-mail 128

### Filters for e-mail 133–137

### Finding

- applications, using Graffiti writing 18
- e-mail addresses 122–123
- information in applications 64–68
- phone numbers 66–67
- using the Find application 66

### Folders for e-mail 130

### Fonts 73, 109

### Formats preferences 168

### Frozen organizer 201

## G

### Games 44, 171

### General preferences

- alarm sounds 171
- auto-off delay 170
- system sounds 171

### Glossary. *See* Graffiti ShortCuts

### Graffiti

- accented characters 34
- alphabet 27, 30
- basic concepts 27
- capital letters 31
- Command stroke 20
- defined 22
- Giraffe game for practicing 44
- how to write characters 28
- menu commands 19
- moving the cursor 35
- numbers 31



- online Help 57, 166
- problems using 202
- punctuation marks 32
- ShortCuts for entering data 35,  
190–191
- symbols 33
- tips 29
- writing 27–36
- writing area 7, 28

## H

- Hard reset 196
- Header information (e-mail) 119, 121
- Help
  - Graffiti 57
  - online tips 20
- Hiding records 70
- High Priority e-mail filter 136
- HotSync
  - buttons preferences 168
  - conduits for synchronizing
    - applications 146–147,  
197
  - customizing 146
  - defined 58
  - first-time operation 59–60,  
162–163
  - for managing desktop E-Mail  
117–118
  - HotSync Manager 59
  - IR operation 148–153
  - linking to external files 161
  - local operation 60, 144, 205
  - Manager 149, 151
  - modem operation 145, 153–157,  
206–207
  - modem settings 154
  - network operation 158–161
  - operations using cradle 152, 172
  - operations using IR port  
151–152, 173–174
  - options for filtering e-mail  
132–137
  - problems with 204–209
  - problems with IR 207

- setting options 143–145
- for synchronizing data 12
- using with another PIM 45

## I

- Icons
  - alarm 78
  - application 16, 40
  - note 72
  - online Tips 20
  - onscreen 202
  - repeating event 80
- Idle timeout of ISP or server  
connection 182
- Ignoring e-mail. *See* Filters for e-mail
- Importing data 24, 37–38
- Inbox 130
- Infrared
  - connections 172
  - HotSync operations 151–152,  
173–174
  - installing Windows 95 driver  
149
  - port 9, 148, 150
  - problems with IR HotSync  
operations 207
  - requirements for computer 148
- Installing
  - applications 42–44
  - conduit to install applications  
146
  - Desktop software 13, 200
  - Mail. *See* Mail, desktop  
configuration
- International characters
  - Graffiti writing 34
  - onscreen keyboard 36
- IP address 181, 183
- IR port
  - See also* Beaming and Infrared
- IR. *See* Infrared
- IrCOMM 148, 172
- IrDA (Infrared Data Association) 148
- Items. *See* To Do List or Expense

## K

### Keyboard

- computer 27
- onscreen 16, 36, 167

## L

### Letters

- font style 73
- Graffiti 27, 30
- onscreen keyboard 36

### List, in Applications Launcher 40

### Lithium-ion battery 11

### Locking the organizer with a password 47–48, 167, 189

### Login scripts 184–187, 223

### Looking up Address Book data

- to add to other records 66–67
- scrolling in Address list 65
- to add to e-mail addresses 122–123

### Lost

- organizer, contact for 89
- records 203

### Lotus

- 1-2-3, for expense reports 222
- cc:Mail 116
- Organizer, importing data from 37

## M

### Macintosh 4, 109, 148, 184

### Mail

- address lookup 122–123
- attachments 133
- BCC (blind carbon copy) 123, 124
- changing setup 118
- closing 119
- confirm delivery 123, 126
- confirm read 123, 126
- creating 119–121
- deleting e-mail 129
- desktop configuration 116–118
- draft e-mail 127

### editing unsent e-mail 126

### filing e-mail 128

### filtering options 132–137

### folders 130

### HotSync options 117–118

### menus 138

### opening 118

### overview 115–116

### priority of delivery 123, 124

### purging deleted e-mail 130

### recovering deleted 129

### replying to e-mail 121

### sending 126

### showing dates 131

### signature 123, 125–126

### sorting 131

### synchronizing 118

### truncating 137

### viewing e-mail 118

### Main applications 17

### Maintenance information 193

### Masking records 70

### Memo Pad

- adding Address Book data to records 67

### archive files (.mpa) 37

### categorizing records 61

### conduit for synchronizing 146

### creating records 55, 98

### deleting records 57, 81

### dragging memos into other applications 53

### fonts 73

### menus 99, 102

### opening 53

### overview 53

### private records 71

### reviewing memos 98

### sorting records 69, 203

### Memory

### amount of free 212

### for beaming 210

### Calculator 101

### regaining 58, 201

### Memos. *See* Memo Pad

### Menus 18–20, 202

### Address Book 91

- choosing 19
- command equivalents (Graffiti writing) 19
- command toolbar 20
- Date Book 86
- Edit menu 56–57
- Expense 112
- Mail 138
- Memo Pad 99, 102
- menu bar 16, 19
- Network Preferences 187
- To Do List 97
- Microsoft
  - Excel, transferring Expense data to 108–112
  - Exchange 116
  - Outlook, connecting to 14, 204
  - Windows 95, 98 148
- Modem
  - connections 172
  - HotSync operations via 153–157, 206–207
  - setup after upgrade 5
- Monday, to start week 169
- Month (Date Book view) 84, 87
- Moving the cursor (Graffiti writing) 35
- MPA (Memo Pad archive file) 37

## N

- Network
  - connecting 181
  - connection type 182
  - HotSync operation 158–161
  - idle timeout 182
  - login scripts 184–187
  - password 177
  - phone settings 178
  - preferences 175–189
  - primary DNS 183
  - secondary DNS 183
  - selecting connection 177
  - selecting service 175
  - TCP/IP 175
  - user name 176
- Notes, attaching to records 72

- Numbers
  - decimal point and thousands separator 169
  - Graffiti writing 31
  - onscreen keyboard 16, 21, 36

## O

- 1-2-3, for expense reports 222
- Onscreen keyboard 21, 36, 57
  - pen stroke to open 167
- Opening
  - Address Book 51
  - applications 17–18
  - Calculator 54
  - Date Book 50
  - Expense 54
  - Mail 118
  - Memo Pad 53
  - To Do List 52
- Organizer (Lotus PIM) 37
- Outbox 126, 130
- Outlook, connecting to 14, 204
- Overlapping events 84
- Owner preferences 189

## P

- Palm Desktop software. *See* Desktop software
- Passwords 46–48
  - changing 47
  - creating 46
  - deleting 47
  - for network 177
  - forgotten 48, 211
- Pasting text 56
- Payment, Expense item 105
- Pen stroke, full-screen 166–167
- Personal information managers. *See* PIM
- Phone Lookup 66–67
- Phone numbers
  - selecting for Address list 91
  - selecting types 89
- Phone settings for ISP or dial-in server 178–180

- Pick lists 16
- PIM (personal information manager)
  - using HotSync Manager with 45
  - using with organizer 14
  - See also* Desktop software
- Plug-in applications 187
- Ports
  - IR on handheld 148
  - simulated for infrared communication 150
  - See also* Serial port
- Power button 6
- PPP 181
- PRC (application file extension) 43, 187
- Preferences 24
  - Buttons 166
  - choosing 41
  - Connection 175
  - cradle setting 170
  - Digitizer 168
  - Formats 168
  - General 170
  - HotSync buttons 168
  - Network 175–189
  - Owner 189
  - ShortCuts 190
- Primary DNS 183
- Printing
  - expense reports from Excel 109–112
  - records from applications 12
- Prioritizing To Do List records 93, 97
- Priority of delivery (e-mail) 124
- Private records
  - displaying and creating 70–72, 203
  - lost with forgotten password 48
  - See also* Security
- Profiles 162
- Punctuation marks
  - Graffiti writing 32
  - onscreen keyboard 36
- Purging
  - deleted e-mail 130
  - records 58
  - See also* Deleting

## Q

- Quattro Pro, for expense reports 222

## R

- Range of times in Day view 87
- Reading e-mail on organizer 118
- Receipts, recording in Expense 104
- Receiving data. *See* Beaming information
- Recharging the battery 11–12, 170
- Records
  - Address Book 88
  - beaming 139–140
  - choosing categories 61
  - creating 55
  - Date Book 74
  - defined 55
  - deleting 57, 80
  - displaying a category of 62
  - editing 55–57
  - Expense 103
  - fonts 73
  - hiding private 46, 70
  - lost 203
  - masking private 46, 70
  - Memo Pad 98
  - notes for 72
  - number of 212
  - private 70–72
  - purging 58
  - sorting 69–70
  - To Do List 93
- Recovering
  - deleted e-mail 129
  - filed mail 129
- Removing
  - applications 45
  - Desktop software 45
- Renaming categories 64
- Repeating events
  - deleting from Date Book 57
  - scheduling 79
- Replying to e-mail 121
- Rescheduling events 78
- Resetting organizer
  - hard reset 196

- location of reset button 9, 195
- soft reset 195

Retrieving e-mail. *See* Filters for e-mail

## S

### Saving

- data 39, 55, 57
- draft e-mail 127

### Scheduling events 74–78

### Screen

- blank 201
- calibrating 15, 168
- caring for 193
- touching with your finger 7

### Scroll

- bar 17
- button 7

### Searching. *See* Finding

### Secondary DNS 183

### Security 46–48

- changing password 47
- deleting password 47
- displaying owner's name 189
- forgotten password 48
- locking the organizer 47
- private records 70–72

### Selecting

- date for event 76
- e-mail to be synchronized. *See* Filters for e-mail 133
- phone numbers in Address Book 89
- text 56, 57

### Sending

- data. *See* Beaming information
- e-mail 119–121, 126

### Serial

- connections 172
- connector 10
- port 10, 145, 153

### Service

- selecting for network 175
- templates 181, 187

### Settings. *See* Preferences

### ShortCuts

- backing up 146
- managing 190–191
- menu commands 19
- predefined 36
- using 35

### Showing dates in Mail list 131

### Signature for e-mail 125–126

### Simulated port for infrared communication 150

### Soft reset 195

### Sorting

- applications 40
- e-mail items 131
- records 69–70, 203

### Sounds. *See* Alarm and System sounds

### sounds

### Starting applications 18

### Storing e-mail 128

### Stylus

- dragging with 15
- pen stroke to activate a feature 166
- tapping with 15
- writing with 9, 27

### Sunday, to start week 169

### Symbols

- for currency 106
- in Graffiti writing 33

### Synchronizing data. *See* HotSync

### System

- conduit 146
- requirements for Desktop software 4
- sounds 171

## T

### Tab delimited files, importing data from 37

### Tapping 15, 202

### TCP/IP 175, 188

### TDA (To Do List archive file) 37

### Technical Support 199, 212

### Templates for expense reports 111

### Text

- copying 56
- cutting 56

- entry. *See* Entering data
- files, importing data from 37
- fonts for 73
- selecting all 57
- Thousands separator 169
- Time
  - alarm setting 78
  - bars in Date Book 86
  - format 169
  - setting current 25
  - setting event 74
  - start and end for Date Book Day
    - view 87

Tips, online 20

To Do List

- adding Address Book data to
  - records 67
- archive files (.tda) 37
- categorizing records 61, 97
- checking off items 94
- completed items 96
- completion date 96
- conduit for synchronizing 146
- creating records 55, 93
- deleting records 57, 81
- due date 95, 96, 97
- fonts 73
- menus 97
- notes for records 72
- opening 52
- overview 52
- prioritizing records 93, 97
- private records 71
- purging records 58, 96
- sorting records 69

Today. *See* Current date

Transferring data. *See* HotSync

Transmitting data. *See* Beaming information

Troubleshooting 207

Truncating e-mail 137

- Turning off organizer
  - automatically 170
  - pen stroke for 167
  - problems with 201

- Turning on organizer
  - application buttons 7
  - displaying owner's name 189
  - power button 6
  - problems with 201

## U

Undoing actions 56

Uninstalling Desktop software 45

Unresponsive organizer 201

Unsent e-mail, editing 126

Untimed events 74, 77, 79

Updating data. *See* HotSync

Upgrading Desktop software 4

User name

- for ISP 176

- identifying organizer 189

User profiles 162

## V

Vendor for Expense item 105

## W

Web sites 14, 149

Week (Date Book view) 82–83, 169, 203

Writing area 7

Writing. *See* Entering data

## X

XLT (Expense report template in Excel) 111